

Lecture 16

Chemical Reaction Engineering (CRE) is the field that studies the rates and mechanisms of chemical reactions and the design of the reactors in which they take place.

Web Lecture 16

Class Lecture 25 – Thursday 4/18/2013

- Bioreactors
 - Monod Equation
 - Yield Coefficients
 - Washout

Review Last Lecture

Enzymes - Urease

A given enzyme can only catalyze only one reaction. Urea is decomposed by the enzyme urease, as shown below.

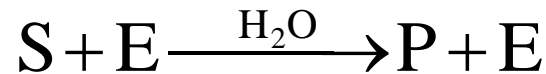
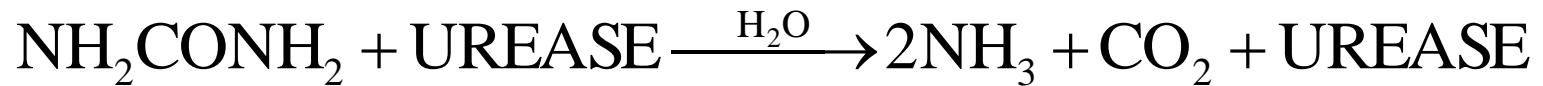

The corresponding mechanism is:

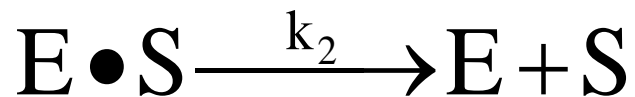
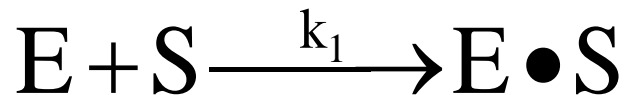

Michaelis Menten Equation

$$r_P = -r_S = \frac{V_{\max} S}{K_M + S}$$

Bioreactors

$$r_P = -r_S = \frac{V_{\max} S}{K_M + S}$$

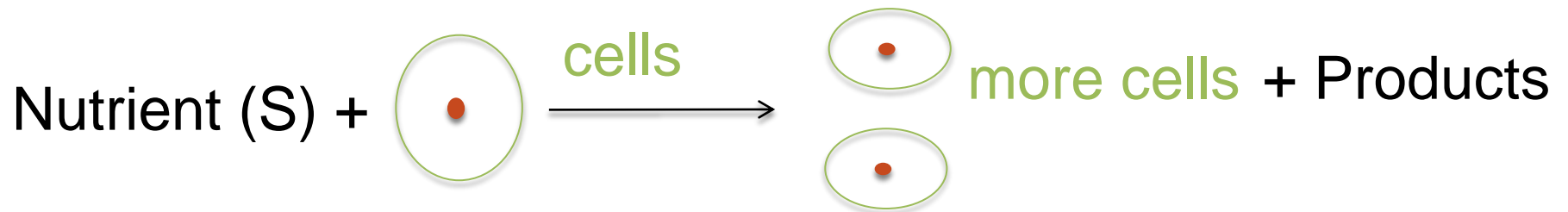

$$r_g = \mu_{\max} \frac{C_C C_S}{K_S + C_S}$$

Bioreactors

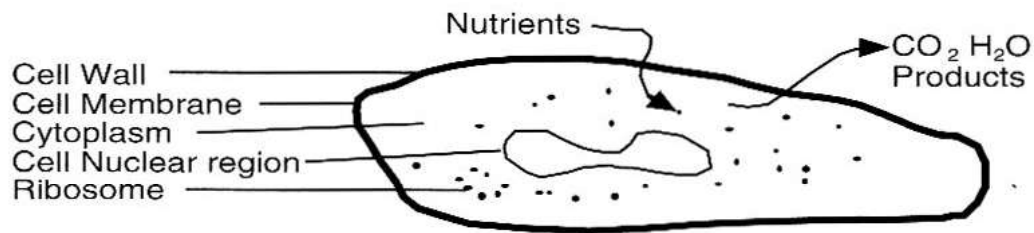

(a)

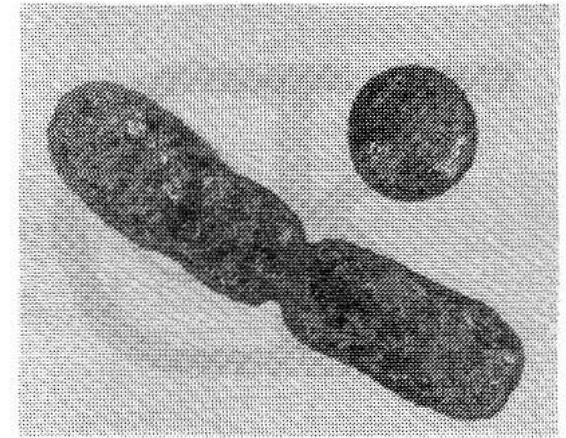

(b)

Figure 7-15 (a) Schematic of cell (b) Photo of cell dividing *E. coli*. Courtesy of D. L. Nelson and M. M. Cox, *Lehninger Principles of Biochemistry*, 3rd ed. (New York: Worth Publishers, 2000).

Batch Bioreactor

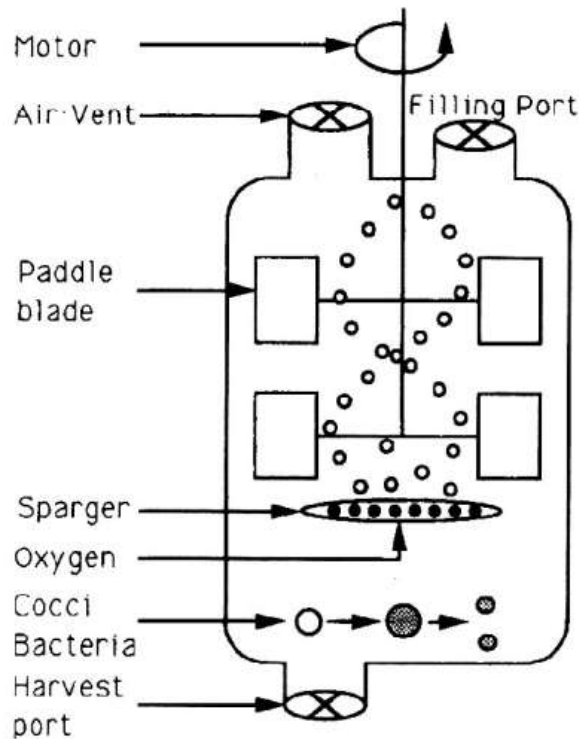

Growth

Bacteria

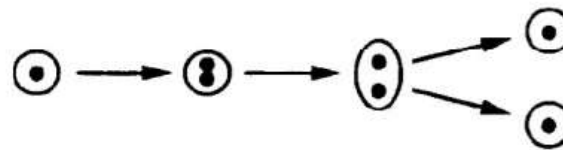

Yeast Budding

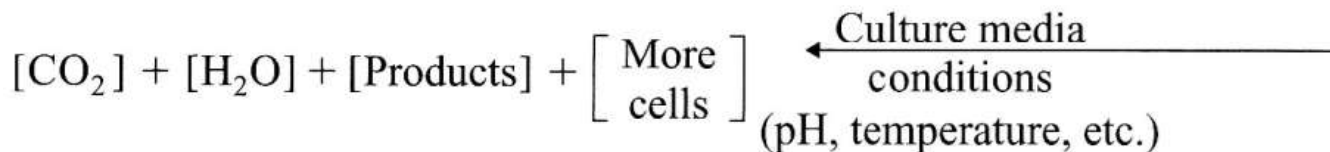
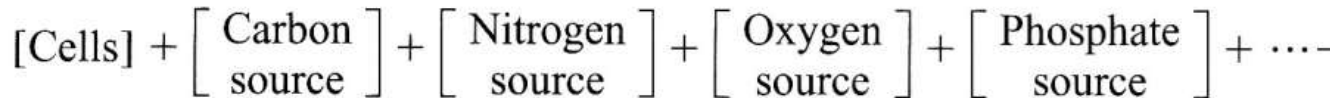
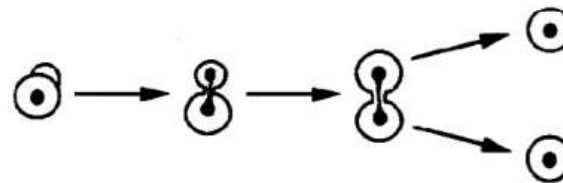

Phases of Cell Growth and Division

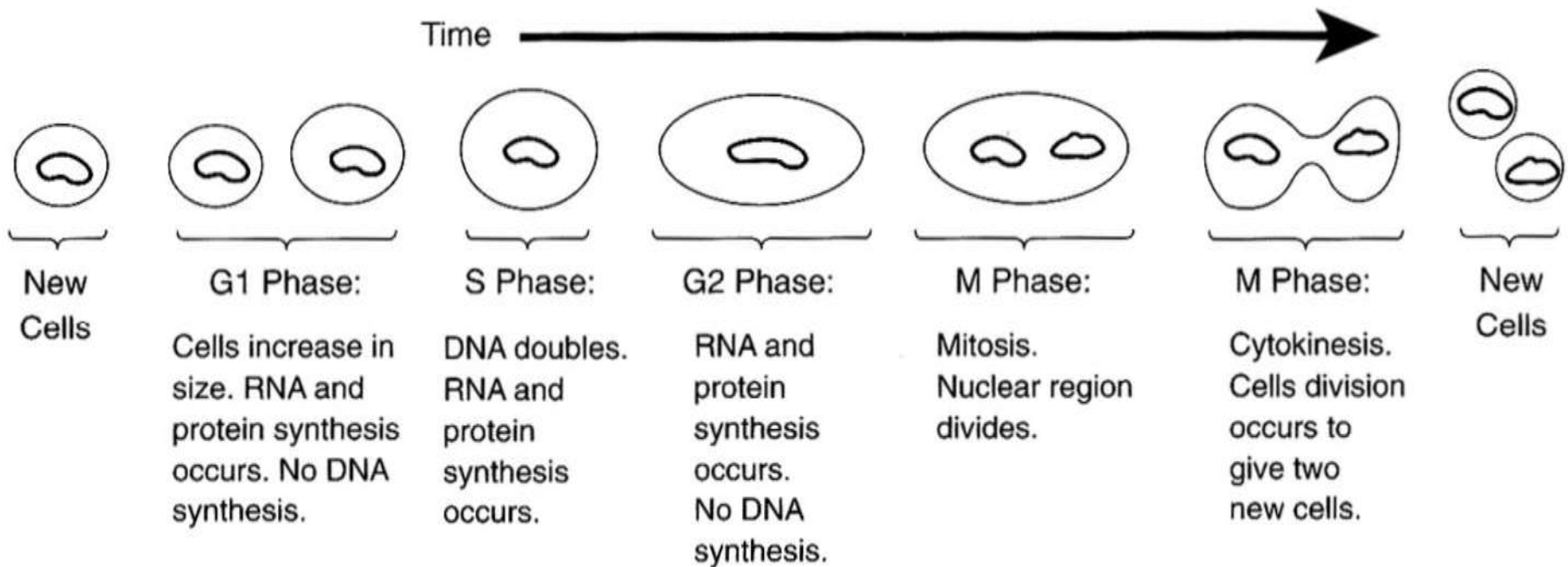

Bioreactors

inoculum

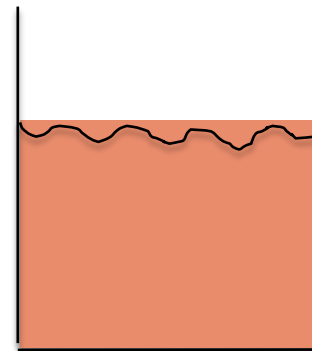
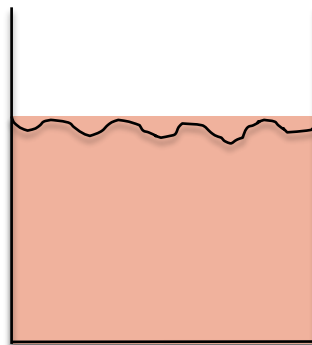
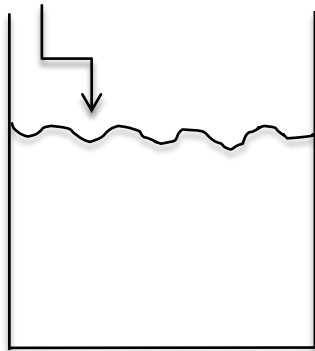
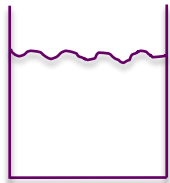

t=0 time →

Cells + Substrate → More Cells + Product

Bacterial Growth

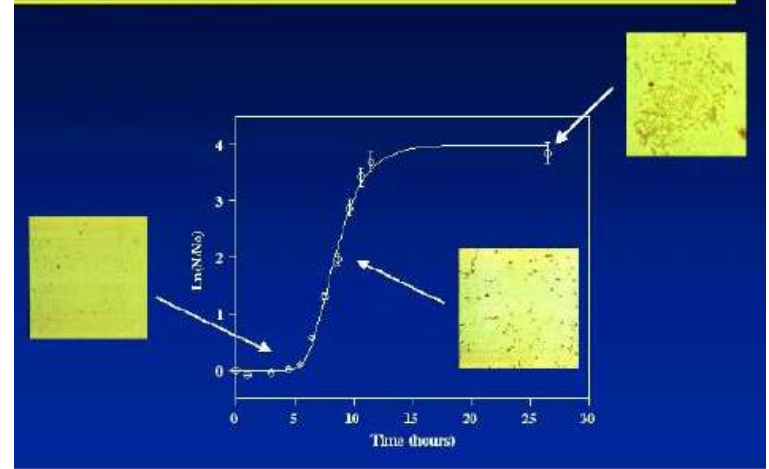

Bioreactors

a) Phases of bacteria growth:

I. Lag II. Exponential III. Stationary IV. Death

b) Monod growth rate law: $r_g = \mu_{\max} \frac{C_C C_S}{K_S + C_S}$

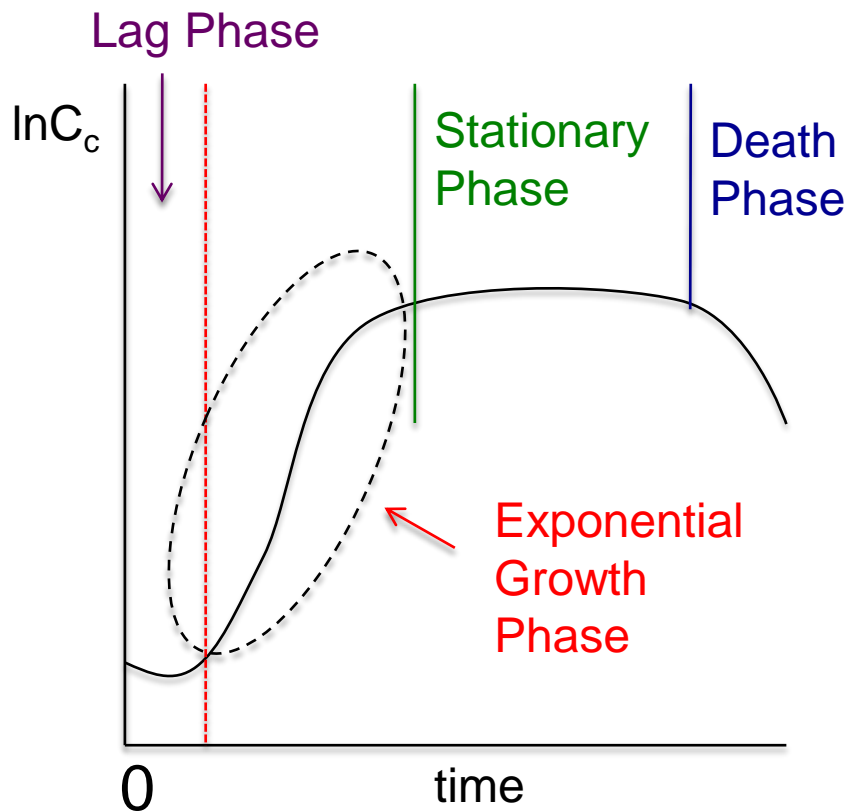

Bioreactors

1) Mass Balances

Accumulation = [In] - [Out] + [Growth] - [Death]

$$V \frac{dC_C}{dt} = v_0 C_{C0} - v_0 C_C + Vr_g - Vr_d$$

Let $D = v_0 / V$

$$(1) \frac{dC_C}{dt} = D(C_{C0} - C_C) + r_g - r_d$$

Bioreactors

$$(1) \quad \frac{dC_C}{dt} = D(C_{C0} - C_C) + r_g - r_d$$

$$(2) \quad \frac{dC_S}{dt} = D(C_{S0} - C_S) + r_S$$

Rate Laws:

$$(3) \quad r_g = k_{OBS} \left(\frac{\mu_{\max} C_S}{K_S + C_S} \right) C_C$$

$$(4) \quad k_{OBS} = \left(1 - \frac{C_P}{C_P^*} \right)^n$$

C_P^* = Product concentration at which all metabolism ceases

Bioreactors

3) Stoichiometry

A) Yield Coefficients

$$Y'_{c/s} = \frac{\text{mass of new cells formed}}{\text{mass of substrate to produce new cells}} \quad Y'_{s/c} = \frac{1}{Y'_{c/s}}$$

$$Y'_{p/s} = \frac{\text{mass of product formed}}{\text{mass of substrate consumed to form product}}$$

B) Maintenance

$$(5) \quad m = \frac{\text{mass of substrate consumed for maintenance}}{\text{mass of cells} \cdot \text{time}}$$

$$-r_S = r_g Y_{S/C} + r_P Y_{S/P} + m C_C$$

Bioreactors

3) Stoichiometry

Rate of Substrate Consumption

$$-r_S = r_g Y'_{S/C} + r_P Y'_{S/P} + m C_C$$

Can't separate substrate consumption used for cell growth from that used for product formations during exponential growth.

$$-r_S = r_g Y'_{S/C} + m C_C$$

$$Y'_{S/C} = \frac{\text{(grams of substrate consumed)}}{\text{(grams of cells produced)}}$$

Bioreactors

Volume= V

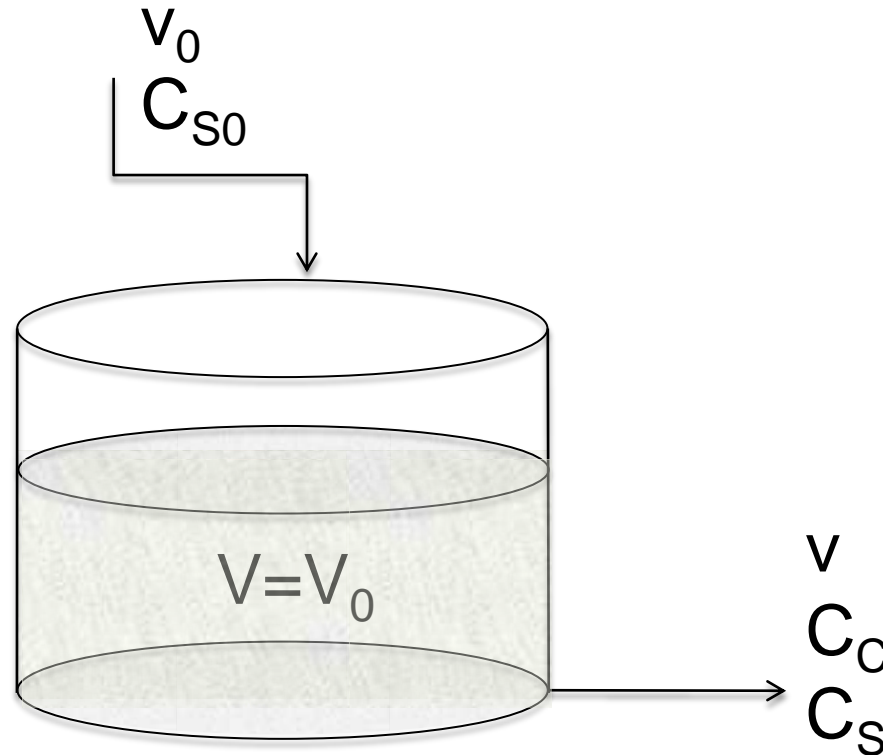

1) Mass Balance:

$$V \frac{dC_C}{dt} = 0 - v_0 C_C + (r_g - r_d) V \quad (\text{cells})$$

Bioreactors

$$V \frac{dC_C}{dt} = 0 - v_0 C_C + (r_g - r_d)V \quad (\text{cells})$$

$$V \frac{dC_S}{dt} = v_0 C_{S0} - v_0 C_S + r_S V \quad (\text{substrate})$$

$$D = \frac{1}{\tau} = \frac{v_0}{V} \quad (\text{dilution rate})$$

$$(1) \quad \frac{dC_C}{dt} = -DC_C + (r_g - r_d)$$

$$(2) \quad \frac{dC_S}{dt} = D(C_{S0} - C_S) + r_S$$

$$(3) \quad \frac{dC_P}{dt} = DC_P - r_P \quad (\text{product})$$

Bioreactors

2) Rate Laws:

$$(4) \quad r_g = \frac{\mu_{\max} C_S}{k_S + C_S} C_C K_{OBS}$$

$$(5) \quad K_{OBS} = \left(1 - \frac{C_P}{C_P^*}\right)^n$$

$$(6) \quad r_P = Y_{P/C} r_g$$

$$(7) \quad r_S = -Y_{S/C} r_g - m C_C$$

$$(8) \quad r_D = k_D C_C$$

3) Parameters

μ_{\max} , C_P^* , n , k_S , k_D , $y_{S/C}$, $y_{P/C}$, m , D , C_{S0}

$\dot{m} = v_0 C_C$, $\dot{m}_p = v_0 C_P$, $v_0 = DV$, V

Polymath Setup

1.) $d(C_C)/d(t) = -D * C_C + (r_g - r_d)$

2.) $d(C_S)/d(t) = -D * (C_{S0} - C_S) - Y_{sg} * r_g - m * C_C$

3.) $d(C_P)/d(t) = -D * C_P + Y_{PC} * r_g$

4.) $r_g = (((1 - (C_P / C_{pstar})) ** 0.52) * mumax * (C_S / (K_S + C_S))) * C_C$

5.) $D = 0.2$

6.) $k_d = 0.01$

7.) $r_d = k_d * C_C$

8.) $C_{S0} = 250$

9.) $Y_{PC} = 5.6$

10.) $m = 0.3$

11.) $mumax = 0.33$

12.) $Y_{SC} = 12.5$

13.) $K_S = 1.7$

Bioreactors – Chemostats - CSTRs

1. Steady State - Neglect Death Rate and Cell Maintenance

2. Cell

$$0 = -DVC_C + r_g V$$

$$DC_C = r_g = \frac{\mu_{\max} C_S}{K_S + C_S} C_C = \mu C_C$$

$$D = \mu = \frac{\mu_{\max} C_S}{K_S + C_S}$$

$$C_S = \frac{DK_S}{\mu_{\max} - D}$$

Bioreactors – Chemostats – CSTRs

3. Substrate $0 = D[C_{S0} - C_S]V + r_S V$

$$D[C_{S0} - C_S] = -r_S = Y_{S/C} r_g = Y_{S/C} D C_C$$

$$C_C = Y_{C/S} [C_{S0} - C_S] = Y_{C/S} \left[C_{S0} - \frac{DK_S}{\mu_{\max} - D} \right]$$

Bioreactors – Chemostats – CSTRs

CSTR Washout

$$C_C = 0$$

$$\frac{\dot{m}_c}{V} = \frac{v_0 C_C}{V} = DC_C$$

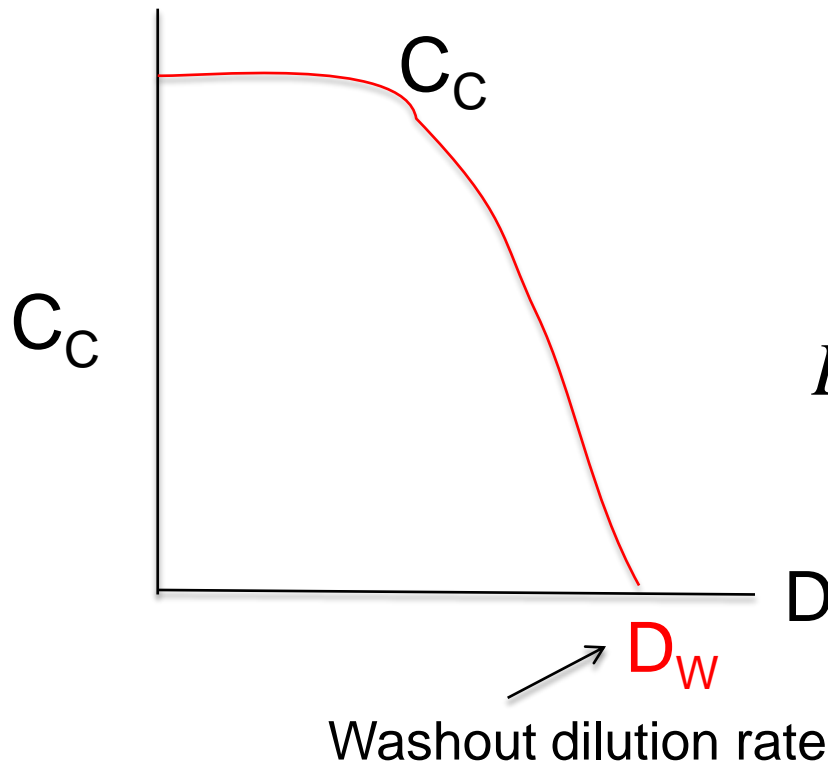

$$DC_C = DY_{C/S} \left[C_{S0} - \frac{DK_S}{\mu_{\max} - D} \right]$$

$$D_W = \frac{\mu_{\max} C_{S0}}{K_S + C_{S0}}$$

Maximum Product Flow Rate

How does this figure relate to drinking a lot of fluids when you have an infection or cold?

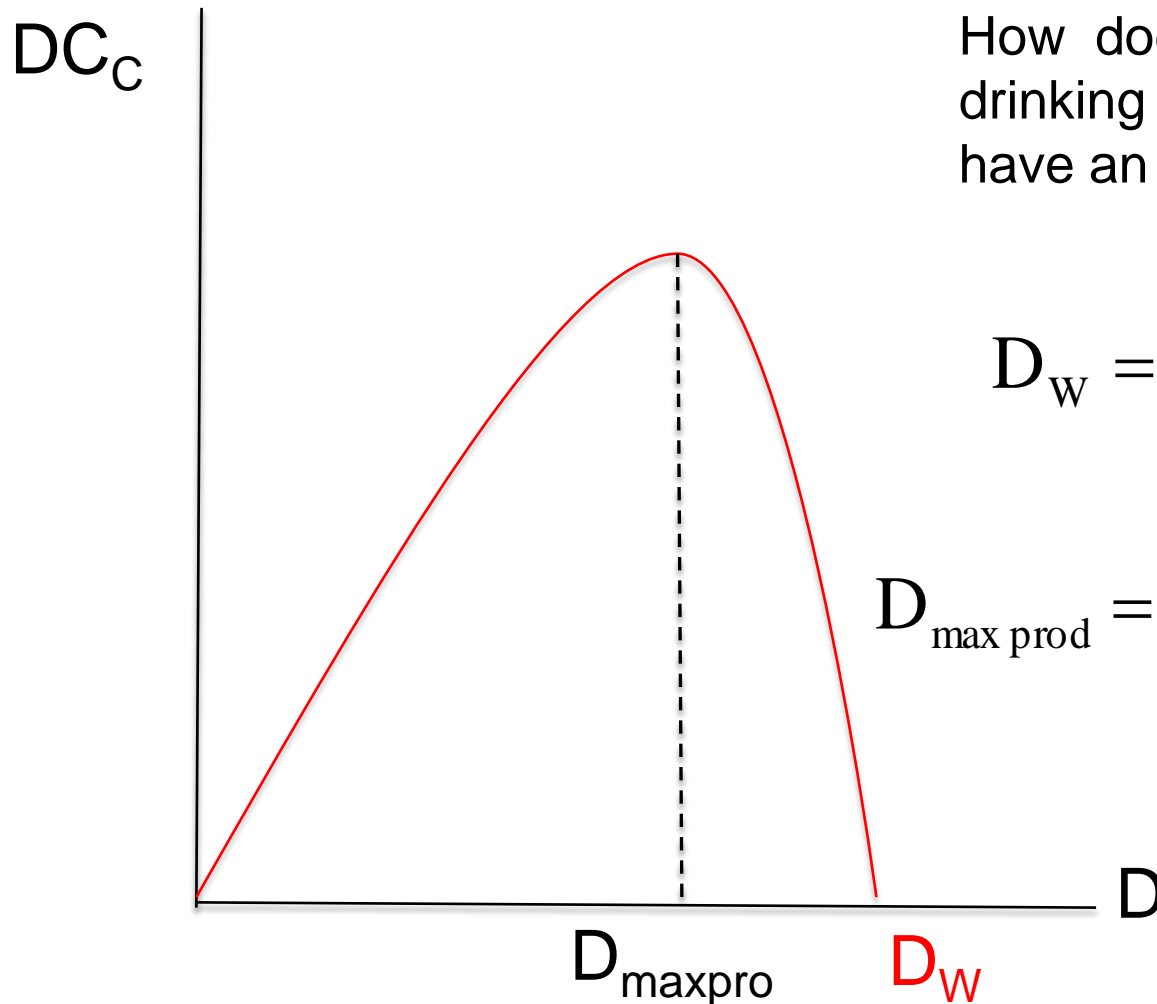

$$D_W = \frac{\mu_{\max} C_{S0}}{K_S + C_{S0}}$$

$$D_{\max\text{prod}} = \mu_{\max} \left(1 - \sqrt{\frac{K_S}{K_S + C_{S0}}} \right)$$

End of Web Lecture 16
End of Class Lecture 25