

CML Lecture Series  
**Primer on Homogenization**

Bing C. Chen

*The University of Michigan, Department of Mechanical Engineering*  
*Computational Mechanics Laboratory*

# Outline

- Model problem: asymptotic analysis for a uni-directional problem
- Asymptotic analysis for elastic problem
- A more intuitive approach
- Implementation issues: symmetry & periodicity
- A Simple example: layered materials

# Heterogeneous Material Problem with highly-oscillating coefficients

- Need very refined meshes to find the local responses

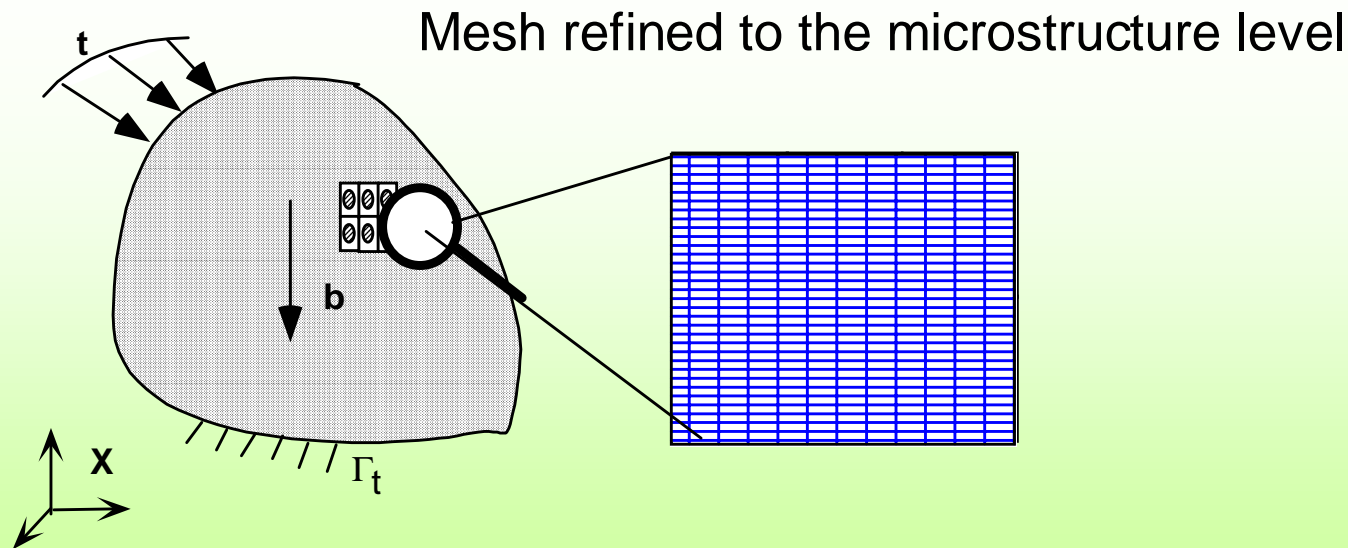

# Multiple-scale problem

- Periodic material properties: rapidly varying

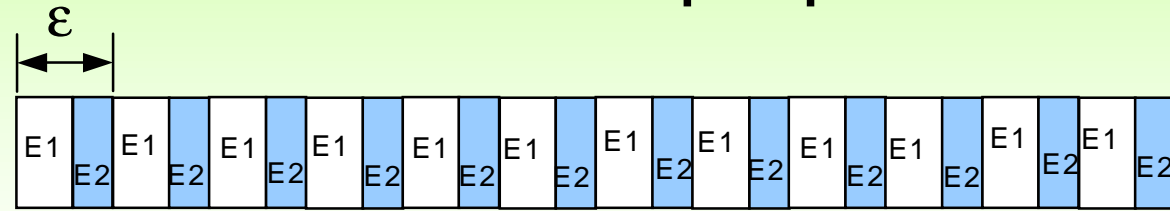

$$\frac{d}{dx} \left( E^\varepsilon \frac{d}{dx} u^\varepsilon \right) + f(x) = 0$$

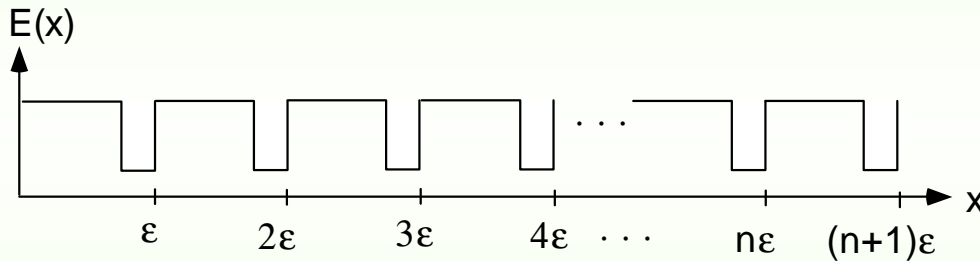

$$E(x + n\varepsilon) = E(x)$$

- Introduce another scale  $y$ ,  
to describe details of oscillation

$$y = x / \varepsilon$$

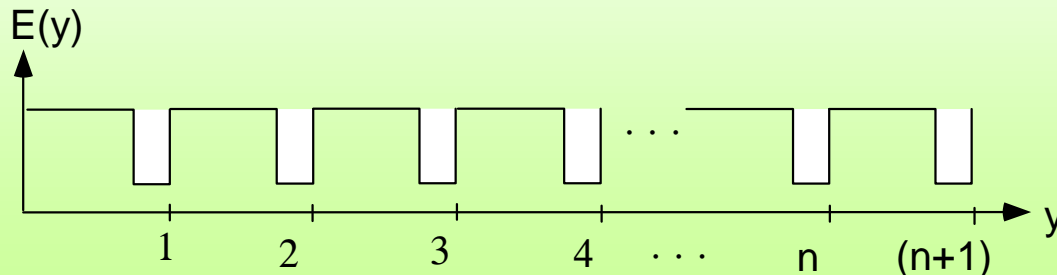

$$E(y + n) = E(y)$$

# Asymptotic Expansion

$$u^\varepsilon(x,y) = u^0(x,y) + \varepsilon u^1(x,y)$$

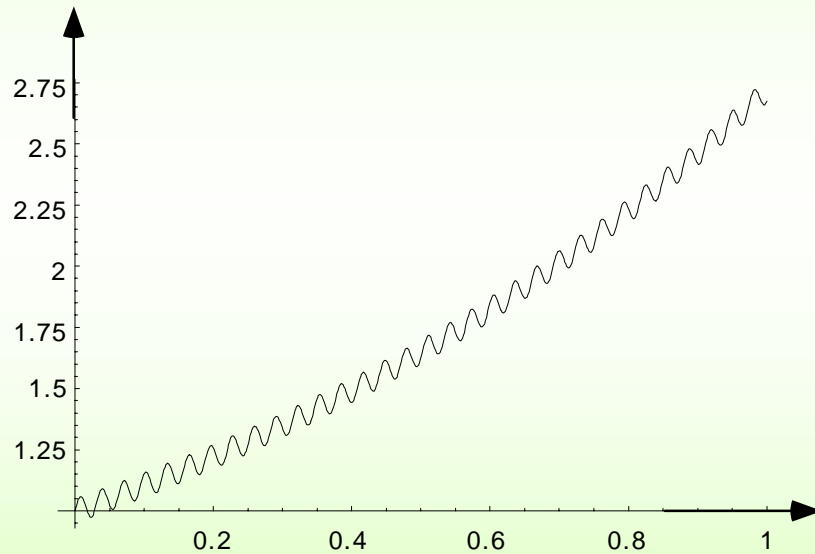

$$y = x / \varepsilon$$

$u^0(x)$  global coordinate  
slowly varying

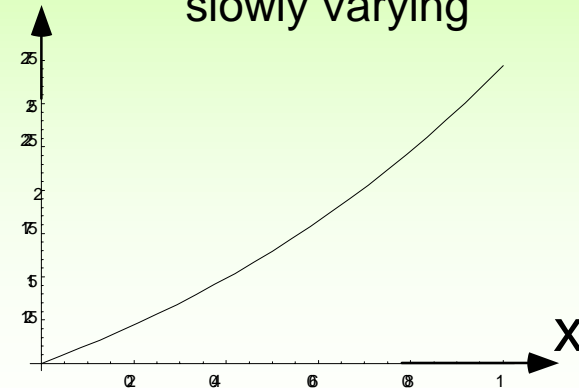

=

+

$u^1(x,y)$

local coordinate  
rapid varying

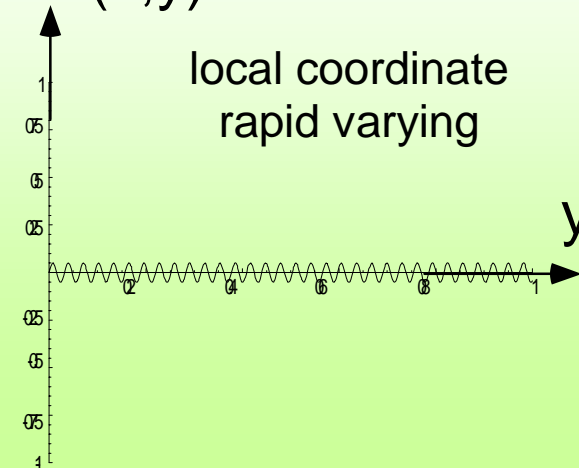

# Asymptotic Expansion: 1D Problem

- Equilibrium equation  $\frac{d}{dx} \left( E^\varepsilon a_x \frac{d}{dx} u^\varepsilon \right) + f(x) = 0$
- Two-scale problem:  $u_i$  periodic

$$u^\varepsilon \mathbf{a}_{x,y} = u_0 \mathbf{a}_{x,y} + \varepsilon u_1 \mathbf{a}_{x,y} + \dots, \quad y = x / \varepsilon$$

$$\frac{d}{dx} \rightarrow \frac{\partial}{\partial x} + \frac{1}{\varepsilon} \frac{\partial}{\partial y}$$

- Replacing the original differential equation

$$\left( \frac{\partial}{\partial x} + \frac{1}{\varepsilon} \frac{\partial}{\partial y} \right) \left( E^\varepsilon a_x \left( \frac{\partial}{\partial x} + \frac{1}{\varepsilon} \frac{\partial}{\partial y} \right) u_0 \mathbf{a}_{x,y} + \varepsilon u_1 \mathbf{a}_{x,y} \right) + f(x) = 0$$

# Expand the equation: Order analysis

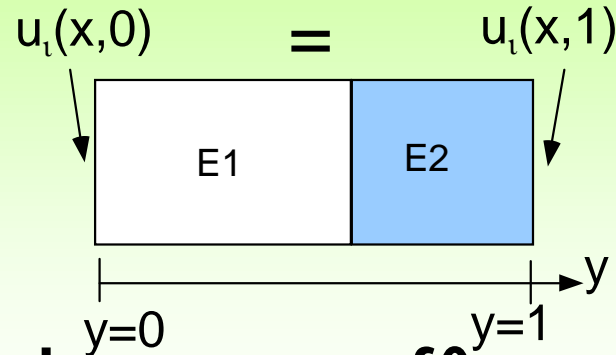

•  $O(\varepsilon^{-2})$   $\frac{\partial}{\partial y} \left( E \frac{\partial u_0}{\partial y} \right) = 0$

$$E \frac{\partial u_0}{\partial y} = c_2(x), \quad \frac{c_2(x)}{E} = \frac{\partial}{\partial y} u_0$$

$$c_2(x) \int_0^1 \frac{1}{E} dY = \int_0^1 \frac{\partial}{\partial y} u_0 dY = u_0|_{y=1} - u_0|_{y=0} = 0$$

$$\Rightarrow c_2(x) = 0, \quad u_0 = u_0 \text{ only}$$

# Order analysis: $O(\varepsilon^{-1})$

●  $O(\varepsilon^{-1})$

$$\frac{\partial}{\partial y} \left[ E a_y f \frac{\partial u_0}{\partial x} + \frac{\partial u_1}{\partial y} \right] = 0$$

$$E a_y f \frac{\partial u_0}{\partial x} + \frac{\partial u_1}{\partial y} = c_1 a_x f$$

$$\int_Y \frac{\partial u_0}{\partial x} dy + \int_Y \frac{\partial u_1}{\partial y} dy = c_1 a_x f \int_Y \frac{1}{E a_y f} dy$$

$$c_1 a_x f = \int_Y \frac{\partial u_0}{\partial x} dy - \int_Y \frac{1}{E a_y f} dy$$

● Microscopic strain proportional to  
Macroscopic strain

$$\frac{\partial u_1}{\partial y} = \frac{1}{E a_y f} \int_Y \frac{dy}{E a_y f} - \int_Y \frac{\partial u_0}{\partial x} dy$$



# Order analysis: $O(\varepsilon^0)$

$$\frac{\partial}{\partial x} \left[ E a_y f \frac{\partial u_0}{\partial x} + \frac{\partial u_1}{\partial y} \right] + \frac{\partial}{\partial y} \left[ E a_y f \frac{\partial u_1}{\partial x} \right] + f(x) = 0$$

$$\frac{1}{Y} \int_Y \frac{\partial}{\partial x} [c_1 a_x f] dy + \frac{1}{Y} \int_Y \frac{\partial}{\partial y} \left[ E a_y f \frac{\partial u_1}{\partial x} \right] dy + \frac{1}{Y} \int_Y f(x) dy = 0$$

$$\frac{\partial}{\partial x} \left[ \frac{1}{Y} \int_Y \frac{1}{E a_y f} dy \right] \frac{\partial u_0}{\partial x} + f(x) = 0$$

$$\frac{\partial}{\partial x} \left[ E^H a_x f \frac{\partial u_0}{\partial x} \right] + f(x) = 0$$

- Homogenized coefficient: harmonic means

$$E^H a_x f = \frac{1}{Y} \int_Y \frac{1}{E a_y f} dy$$

# Energy consideration

- Minimize the strain energy of the unit cell, subject to a given macroscopic strain  $\langle \varepsilon_0 \rangle$

$$\min_{\phi} \frac{1}{2} \frac{1}{Y} \int_Y E(y) \phi^2 dy = \frac{1}{2} E^H \langle \varepsilon_0 \rangle^2$$

$$\forall \phi(0) = \phi(Y)$$

$$\int_Y E(y) \phi \delta \phi dy + \frac{d\phi}{dy} \frac{d\delta\phi}{dy} dy = 0$$

$$- \frac{d}{dy} \left( E(y) \frac{d\phi}{dy} \right) + \frac{d\phi}{dy} \frac{d\delta\phi}{dy} = 0$$

$$E(y) \frac{d\phi}{dy} = c_1$$

$$c_1 = \langle \varepsilon_0 \rangle \int_Y \frac{1}{E(y)} dy$$

$$\frac{1}{2} \frac{1}{Y} c_1^2 \int_Y \frac{1}{E(y)} dy = \frac{1}{2} E^H \langle \varepsilon_0 \rangle^2$$

$$\frac{1}{2} \int_Y \frac{1}{E(y)} dy \langle \varepsilon_0 \rangle^2$$

# Asymptotic Expansion: General Problem

# Global-Local analysis

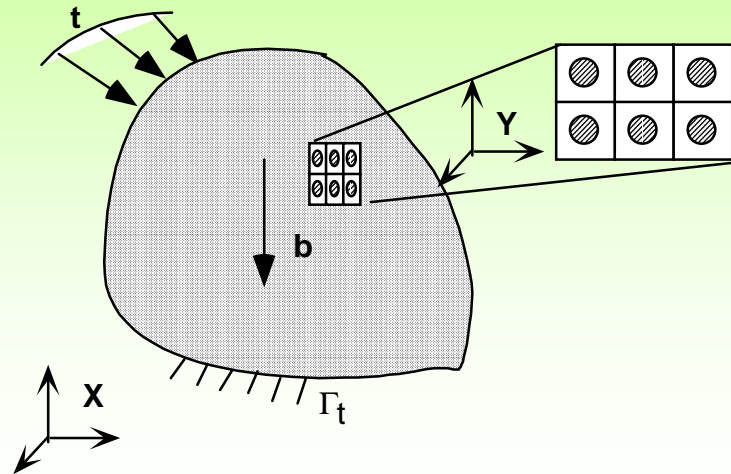

Local analysis  
(PREMAT)

Unit Cell



characteristic displacement:  $\chi$

homogenized coefficient:  $E^h$



Global FEM analysis  
(NASTRAN, ABAQUS)

Localization Process



Unit Cell

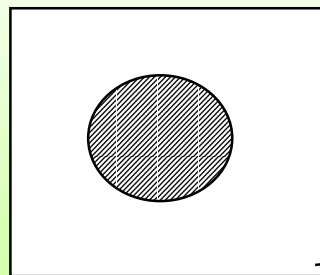

local stress distribution:

$\sigma(x,y)$

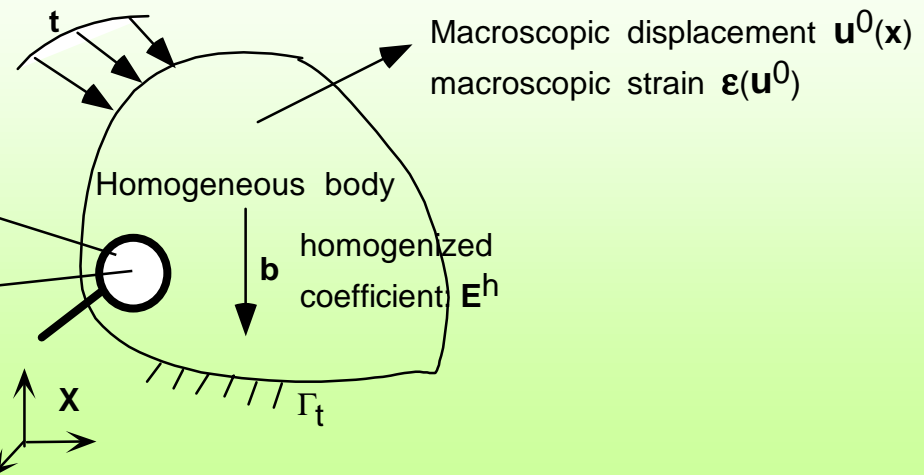
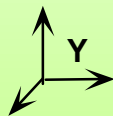

# Asymptotic Expansion: general problem

- Equilibrium equation  $\frac{\partial}{\partial x_j} \left[ \sum_{ijkl} C_{ijkl} \varepsilon \frac{\partial u_k}{\partial x_l} \right] + f_i(x) = 0$
- Two-scale problem

$$u^\varepsilon(\mathbf{x}, \mathbf{y}) = u^{<0>}(\mathbf{x}, \mathbf{y}) + \varepsilon u^{<1>}(\mathbf{x}, \mathbf{y}) + \dots, \quad \mathbf{y} = \mathbf{x} / \varepsilon$$

$$\frac{\partial}{\partial x_j} \rightarrow \frac{\partial}{\partial x_j} + \frac{1}{\varepsilon} \frac{\partial}{\partial y_j}$$

- Replacing the original differential equation

$$\left[ \frac{\partial}{\partial x_j} + \frac{1}{\varepsilon} \frac{\partial}{\partial y_j} \right] \left[ \sum_{ijkl} C_{ijkl} \left( \frac{\partial}{\partial x_l} + \frac{1}{\varepsilon} \frac{\partial}{\partial y_l} \right) u_k^{<0>} + \varepsilon u_k^{<1>} \right] + f(x) = 0$$

# Summary of the order analysis

●  $O(\varepsilon^{-2})$

$$\frac{\partial}{\partial y_j} \left[ L_{ijkl} \frac{\partial u_k^{<0>}}{\partial y_l} \right] = 0$$

$$u^{<0>} = u^{<0>} \text{ only}$$

●  $O(\varepsilon^{-1})$

$$\frac{\partial}{\partial y_j} \left[ L_{ijkl} \frac{\partial u_k^{<1>}}{\partial y_l} \right] = - \frac{\partial L_{ijkl}}{\partial y_j} \frac{\partial u_k^{<0>}}{\partial x_l}$$

$$\frac{\partial u_k^{<1>}}{\partial y_l} = \frac{\partial \chi_k^{pq}}{\partial y_l} \frac{\partial u_p^{<0>}}{\partial x_q}$$

» Eq. of the characteristic displacement  $\chi^{pq}$

$$\frac{\partial}{\partial y_j} \left[ L_{ijkl} \frac{\partial \chi_k^{pq}}{\partial y_l} \right] = - \frac{\partial L_{ijpq}}{\partial y_j}$$

●  $\chi^{pq} = \chi^{qp}$

# Summary of the order analysis (contd)

- $O(\varepsilon^0)$

$$\frac{\partial}{\partial x_j} L_{ijkl} \frac{\partial u_k^{<1>}}{\partial y_l} + \frac{\partial u_k^{<0>}}{\partial y_l} + \frac{\partial}{\partial y_j} L_{ijkl} \frac{\partial u_k^{<1>}}{\partial y_l} + f_i(x) = 0$$

$$\frac{\partial}{\partial x_j} L_{ijkl} \frac{\partial u_k^{<1>}}{\partial y_l} + \frac{\partial u_k^{<0>}}{\partial y_l} + f_i(x) = 0$$

$$\frac{\partial}{\partial x_j} \left[ \frac{1}{Y} \sum_Y L_{ijkl} \delta_{kp} \delta_{lq} + \frac{\partial \chi_k^{pq}}{\partial y_l} \right] \frac{\partial u_p^{<0>}}{\partial x_q} + f_i(x) = 0$$

$$\frac{\partial}{\partial x_j} L_{ijpq}^H \frac{\partial u_p^{<0>}}{\partial x_q} + f_i(x) = 0$$

# Homogenized coefficients

- Homogenized elastic tensor:

$$L_{ijpq}^H = \frac{1}{Y} \int_Y L_{ijkl} \delta_{kp} \delta_{lq} + \frac{\partial \chi_k^{pq}}{\partial y_l} dy$$

- Microscopic equation for  $\chi^{pq}$ , in the variational form

$$\int_Y L_{ijkl} \delta_{kp} \delta_{lq} + \frac{\partial \chi_k^{pq}}{\partial y_l} \frac{\partial v_i}{\partial y_j} dY = 0 \quad \forall v_i$$

- Symmetric form of the homogenized elastic tensor

$$\begin{aligned} L_{mnpq}^H &= \frac{1}{Y} \int_Y C_{im} \delta_{jn} L_{ijkl} \delta_{kp} \delta_{lq} + \frac{\partial \chi_k^{pq}}{\partial y_l} dy \\ &= \frac{1}{Y} \int_Y C_{im} \delta_{jn} + \frac{\partial \chi_i^{mn}}{\partial y_j} L_{ijkl} \delta_{kp} \delta_{lq} + \frac{\partial \chi_k^{pq}}{\partial y_l} dy \end{aligned}$$

- Major/Minor symmetries

$$L_{mnpq}^H = L_{mnqp}^H = L_{nmpq}^H = L_{mnpq}^H$$



# Localization process

- Given macroscopic strain field, find the microscopic stress field

» microscopic strain field

$$\varepsilon_{kl}(\mathbf{x}, \mathbf{y}) = \frac{\partial u_p^{<0>}}{\partial x_q} + \frac{\partial u_k^{<1>}}{\partial y_l} = \mathbb{H}_{pk} \delta_{ql} + \frac{\partial \chi_k^{pq}}{\partial y_l} \frac{\partial u_p^{<0>}}{\partial x_q}$$

» microscopic stress field

$$\sigma_{ij} = L_{ijkl}^{\varepsilon}(\mathbf{x}, \mathbf{y}) \varepsilon_{kl}(\mathbf{x}, \mathbf{y}) = L_{ijkl}^{\varepsilon}(\mathbf{x}, \mathbf{y}) \left[ \mathbb{H}_{pk} \delta_{ql} + \frac{\partial \chi_k^{pq}}{\partial y_l} \frac{\partial u_p^{<0>}}{\partial x_q} \right]$$

» Average stress (volume average)

$$\langle \sigma_{ij} \rangle = \frac{1}{Y} \int_Y \sigma_{ij} dY = L_{ijkl}^H \frac{\partial u_p^{<0>}}{\partial x_q}$$

# More Intuitive Approach

# Engineering approach

- Two domains

Domain: with heterogeneous material

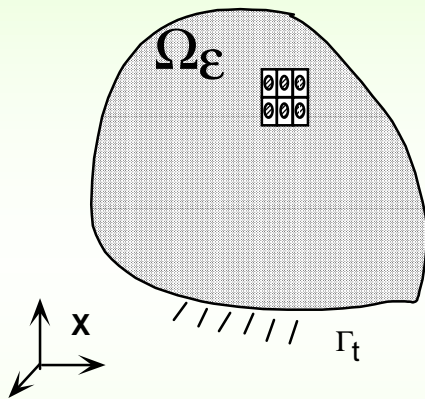

Domain: with homogeneous material

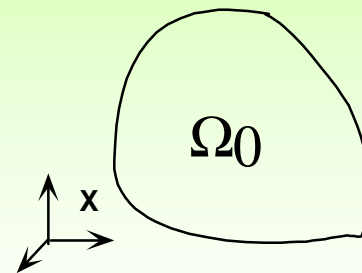

Impose a macroscopic strain:  $\mathbf{E}$   
 Homogeneous stress:  $\mathbf{\Sigma}$   
 Macroscopic constitutive law:  $\mathbf{\Sigma} = \mathbf{L} \mathbf{h} : \mathbf{E}$

+

Unit Cell  $\mathbf{Y}$

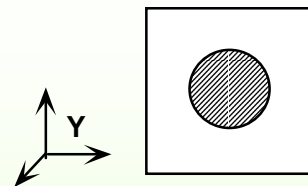

Local strain field  $\boldsymbol{\varepsilon}(\mathbf{u}) = \mathbf{E} + \boldsymbol{\varepsilon}(\mathbf{u}^1)$

- Local strain  $\boldsymbol{\varepsilon}(\mathbf{u}) = \text{overall strain } (\mathbf{E}) + \text{local corrector } \boldsymbol{\varepsilon}(\mathbf{u}^1)$
- small 1st-order variation  $\mathbf{u}^1$  contributes to zero order effect on derivative

$$\frac{\partial u_i^\varepsilon}{\partial x_j} = \frac{\mathbf{E}}{\mathbf{H}} \frac{\partial}{\partial x_j} + \frac{1}{\varepsilon} \frac{\partial}{\partial y_j} \left[ \mathbf{C} u_i^{<0>} \mathbf{a}_x \mathbf{f} + \varepsilon u_i^{<1>} \mathbf{a}_{x,y} \mathbf{f} \mathbf{h} \right] \xrightarrow{\varepsilon \rightarrow 0} \frac{\partial u_i^{<0>}}{\partial x_j} + \frac{\partial u_i^{<1>}}{\partial y_j}$$

# Periodic strain field

- Average operator  $\langle f \rangle = \frac{1}{Y} \int_Y f(\mathbf{y}) d\mathbf{y}$

- Average of the gradient operator

$$\langle \nabla f \rangle = \left\langle \frac{\partial f}{\partial y_i} \right\rangle = \frac{1}{V} \int_Y \frac{\partial f}{\partial y_i} d\mathbf{y} = \frac{1}{V} \int_{\partial Y} (n_i f) dS = 0$$

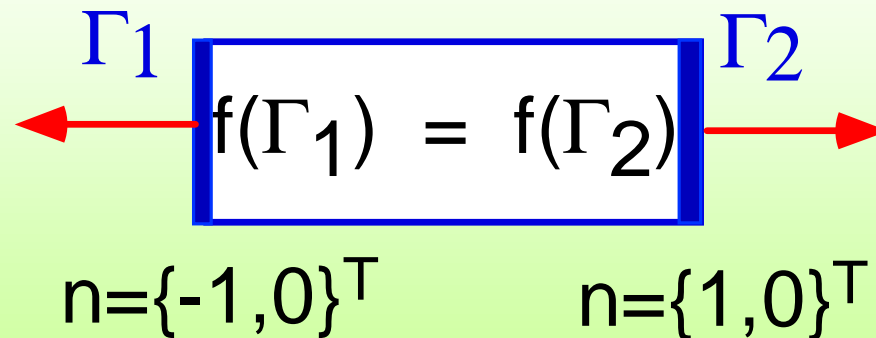

## Periodic strain field (II)

- Average of the strain corrector

$$\langle \varepsilon \mathbf{C} \mathbf{u}^{<1>} \mathbf{h} \rangle = \frac{1}{2} \langle \nabla \mathbf{u}^{<1>} + \mathbf{u}^{<1>} \nabla \rangle = \frac{1}{Y} \int_{\partial Y} \frac{1}{2} \mathbf{C} n_i u_j^{<1>} + n_j u_i^{<1>} \mathbf{h} dS = 0$$

- Average of the microscopic strain

$$\varepsilon \mathbf{d} \mathbf{u} \mathbf{f} = \mathbf{E} + \varepsilon \mathbf{C} \mathbf{u}^{<1>} \mathbf{h}$$

$$\langle \varepsilon \mathbf{d} \mathbf{u} \mathbf{f} \rangle = \langle \mathbf{E} \rangle + \langle \varepsilon \mathbf{C} \mathbf{u}^{<1>} \mathbf{h} \rangle = \mathbf{E}$$

# Periodic stress field

- Local stress field  $\sigma$  satisfies

» in equilibrium  $\operatorname{div} \sigma = 0$  in  $Y$

$\sigma \cdot n$  are opposite on opposite side of unit cell

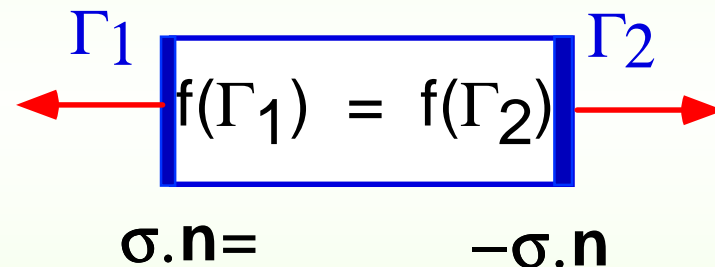

- Overall stress (volume average)

$$\Sigma = \langle \sigma \rangle$$

# Effective properties

- Local problem

» constitutive law:  $\sigma_{\mathbf{y}} = \mathbf{L} : \mathbf{E} + \epsilon \mathbf{C} \langle \mathbf{u} \rangle \mathbf{a}_{\mathbf{y}} \mathbf{f} \mathbf{h} \mathbf{i} \quad \forall \mathbf{y} \in Y$

» equilibrium  $\operatorname{div} \boldsymbol{\sigma} = 0$  in  $Y$ ,  $\boldsymbol{\sigma} \cdot \mathbf{n}$  are opposite

$$\operatorname{div} \mathbf{L} : \epsilon \mathbf{C} \langle \mathbf{u} \rangle \mathbf{a}_{\mathbf{y}} \mathbf{f} \mathbf{h} \mathbf{i} = -\operatorname{div} \mathbf{L} : \mathbf{E} \mathbf{f}$$

$$\int_Y \epsilon \mathbf{a}_{\mathbf{y}} \mathbf{f} : \mathbf{L} : \epsilon \mathbf{C} \langle \mathbf{u} \rangle \mathbf{h} dY = -\int_Y \epsilon \mathbf{a}_{\mathbf{y}} \mathbf{f} : \mathbf{L} : \mathbf{E} dY$$

- linear equation with generalized loading  $\mathbf{E}$

## Thermal-type Loads

$$\int_Y \epsilon^T \mathbf{a}_{\mathbf{y}} \mathbf{f} : \mathbf{L} : \epsilon \mathbf{a}_{\mathbf{y}} \mathbf{f} dY = \int_Y \epsilon^T \mathbf{a}_{\mathbf{y}} \mathbf{f} : \mathbf{L} : \boldsymbol{\alpha} dY$$

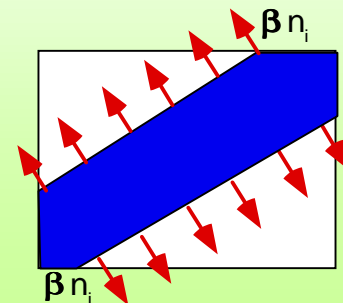

# Local problem: Solution by super-position

- Split the strain into fundamental eigen-strain

$$\mathbf{E} = E_{pq} \mathbf{\Pi}^{pq}, \quad \Pi_{ij}^{pq} = \mathbb{C} \delta_{ip} \delta_{jq} + \delta_{iq} \delta_{jp} \mathbf{h} / 2$$

- solve each sub-problem

$$\int_Y \varepsilon \mathbf{d} \mathbf{u}^f : \mathbf{L} : \varepsilon \mathbf{u}^{<1>} \mathbf{h} dY = - \int_Y \varepsilon \mathbf{d} \mathbf{u}^f : \mathbf{L} : \mathbf{E} dY \quad \forall \delta \mathbf{u}$$

$$\int_Y \varepsilon^T \mathbf{d} \mathbf{u}^f : \mathbf{L} : \varepsilon \chi^{pq} \mathbf{h} dY = \int_Y \varepsilon^T \mathbf{d} \mathbf{u}^f : \mathbf{L} : \mathbf{\Pi}^{pq} dY \quad \forall \delta \mathbf{u}$$

- super-impose the results

$$\mathbf{u}^{<1>} = E_{pq} \chi^{pq}$$

$$\varepsilon \mathbf{d} \mathbf{u}^f = \mathbf{E} + \varepsilon \mathbf{u}^{<1>} \mathbf{h} = E_{pq} \mathbf{d} \mathbf{\Pi}^{pq} + \varepsilon \chi^{pq} \mathbf{h}$$



# Three Load Cases in the homogenization

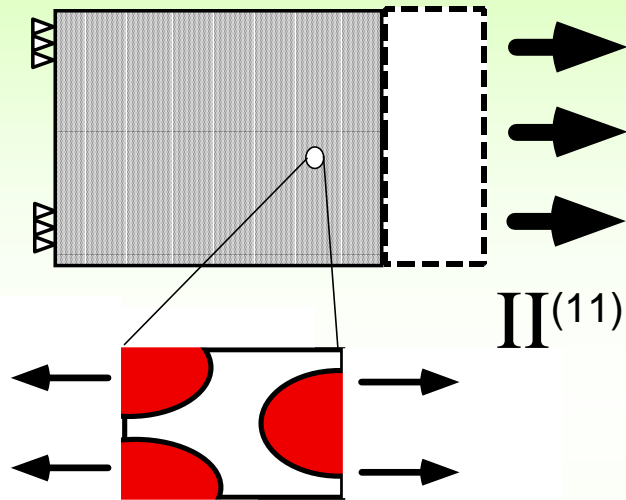

$\Pi^{(11)}$

$$\int_Y \varepsilon \delta u f : L : \varepsilon \mathcal{C} \chi^{(11)} h dY$$

$$= \int_Y \varepsilon \delta u f : L : \Pi^{(11)} dY$$

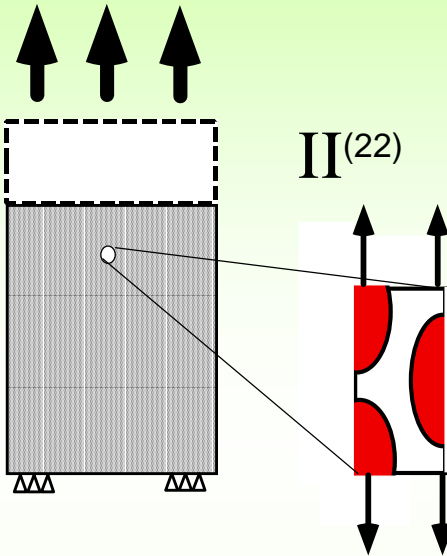

$\Pi^{(22)}$

$$\int_Y \varepsilon \delta u f : L : \varepsilon \mathcal{C} \chi^{(22)} h dY$$

$$= \int_Y \varepsilon \delta u f : L : \Pi^{(22)} dY$$

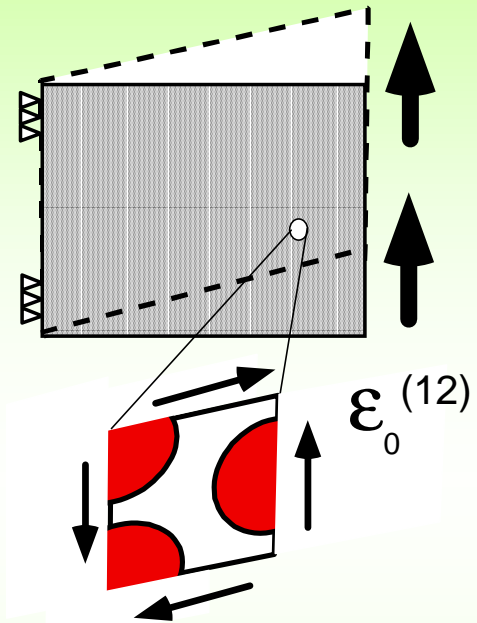

$\varepsilon_0^{(12)}$

$$\int_Y \varepsilon \delta u f : L : \varepsilon \mathcal{C} \chi^{(12)} h dY$$

$$= \int_Y \varepsilon \delta u f : L : \Pi^{(12)} dY$$

# The thermal-load analogy for RHS

## Thermal Loads

$$\int_Y \epsilon \delta u : L : \epsilon dY = \int_Y \epsilon \delta u : L : \alpha dY = \int_Y \epsilon^T \delta u \begin{matrix} R & \beta & U \\ \beta & V & \\ T & 0 & W \end{matrix} dY$$

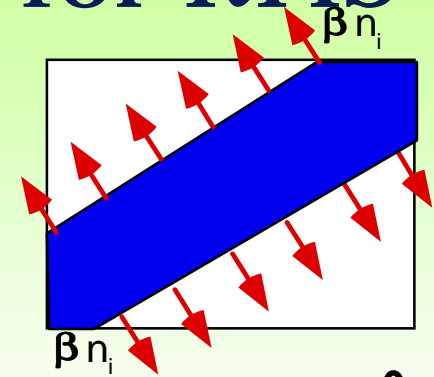

## Thermal-type Loads in the cell problem

$$\int_Y \epsilon \delta u : L : \epsilon \chi^{(pq)} dY = \int_Y \epsilon \delta u : L : \Pi^{(kl)} dY = \int_Y \epsilon \delta u \begin{matrix} \lambda + 2\mu \\ \lambda \\ 0 \end{matrix} \begin{matrix} U \\ V \\ W \end{matrix} \begin{matrix} R & \lambda & U \\ \lambda + 2\mu & & \\ T & 0 & W \end{matrix} \begin{matrix} R & 0 & U \\ 0 & V & \\ T & 0 & W \end{matrix} dY$$

(pq)=11

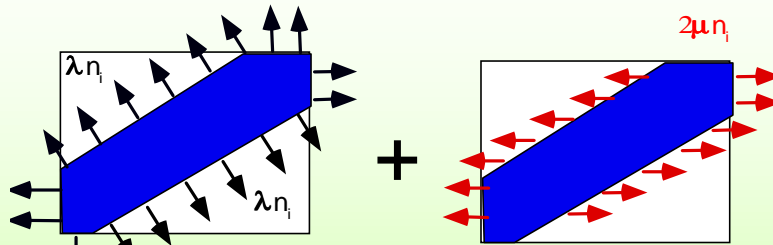

(pq)=22

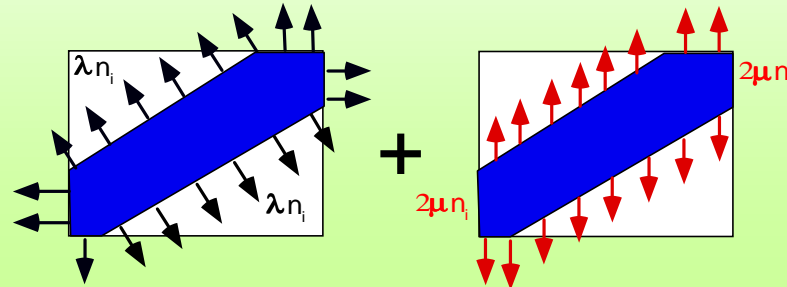

(pq)=12

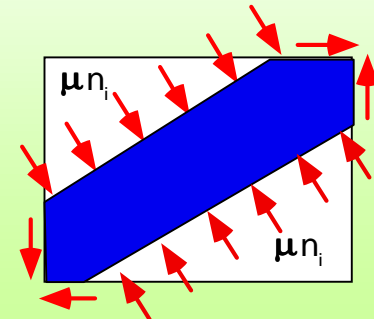

# Effective stiffness tensor

$$\mathbf{L}^H : \mathbf{E} = \Sigma = \langle \boldsymbol{\sigma} \rangle = \langle \mathbf{L} : \boldsymbol{\varepsilon} \mathbf{d} \mathbf{u} \mathbf{f} \rangle = \langle \mathbf{L} : \mathbf{d} \mathbf{E} + \varepsilon \mathbf{C} \mathbf{u}^{<1>} \mathbf{h} \mathbf{i} \rangle$$

strain energy of a homogeneous body subject to macroscopic strain

Average strain energy of the unit cell

$$\mathbf{L}^H : E_{pq} \mathbf{II}^{pq} = E_{pq} \langle \mathbf{L} : \mathbf{d} \mathbf{II}^{pq} + \varepsilon \mathbf{C} \chi^{pq} \mathbf{h} \mathbf{i} \rangle$$

$$\mathbf{L}^H : \mathbf{II}^{pq} = \langle \mathbf{L} : \mathbf{d} \mathbf{II}^{pq} + \varepsilon \mathbf{C} \chi^{pq} \mathbf{h} \mathbf{i} \rangle$$

- Effective stiffness tensor

$$L_{ijkl}^H = \langle L_{ijpq} : \mathbf{d} \mathbf{II}_{pq}^{kl} + \varepsilon_{pq} \mathbf{C} \chi^{kl} \mathbf{h} \mathbf{i} \rangle$$

$$L_{ijkl}^H = \langle \mathbf{d} \mathbf{II}^{ij} + \varepsilon \mathbf{C} \chi^{ij} \mathbf{h} \mathbf{i} : \mathbf{L} : \mathbf{d} \mathbf{II}^{kl} + \varepsilon \mathbf{C} \chi^{kl} \mathbf{h} \mathbf{i} \rangle$$

# Implementation Issues: symmetry & periodicity

# Periodicity conditions

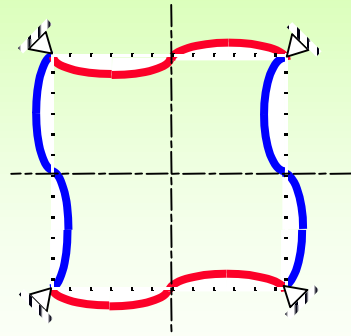

periodicity  
conditions  
enforced  
in the unit  
cell

- Symmetry conditions
- Elimination
- Lagrange multiplier: (MPC)

# Symmetry conditions

- unit cell has planes of symmetry
  - » material properties
  - » geometry
- local problem can be solved (1/2 or 1/4 model) with standard B.C. on the plane of symmetry

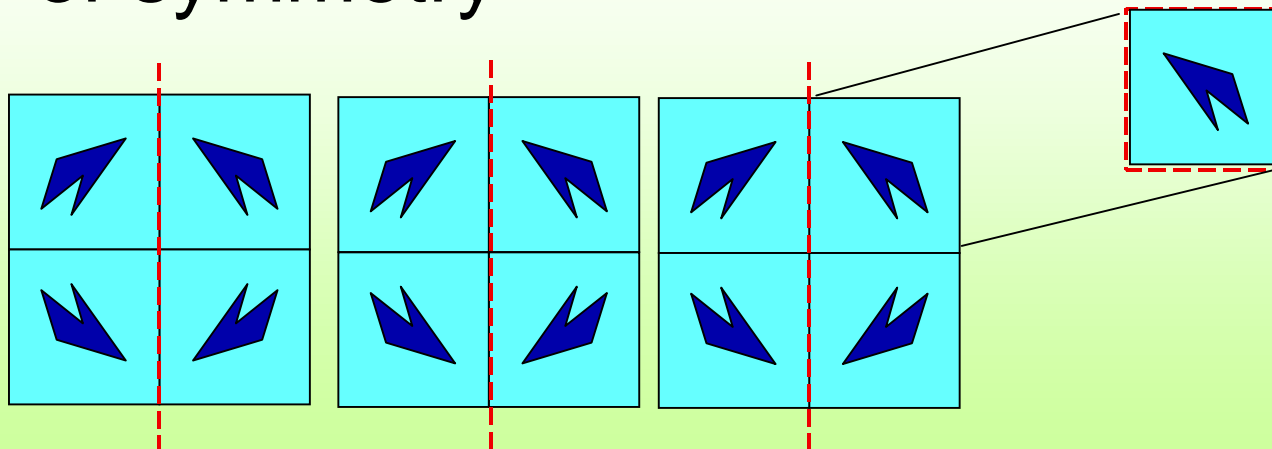

# Symmetry conditions (II)

- Symmetric loads (pq=11, 22)

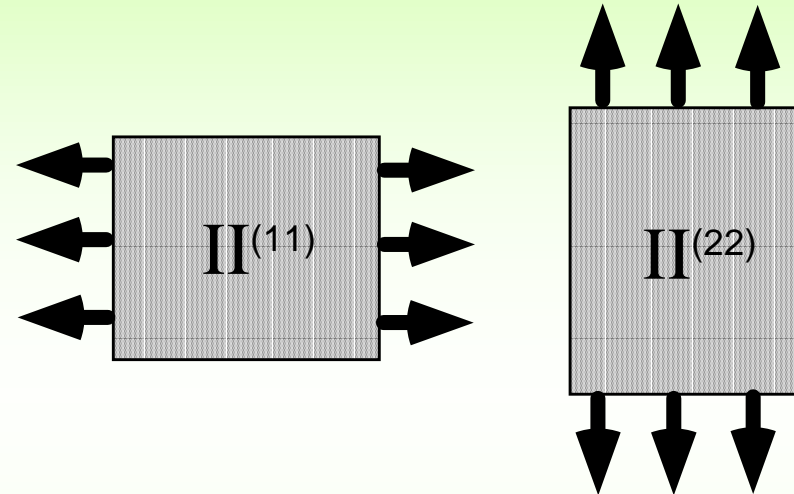
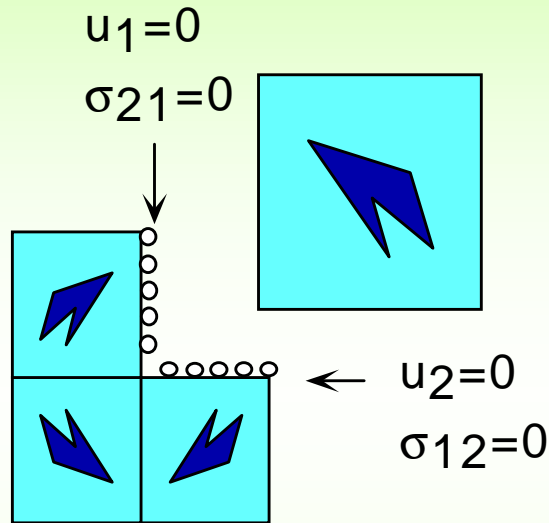

- anti-symmetric load (pq=12)

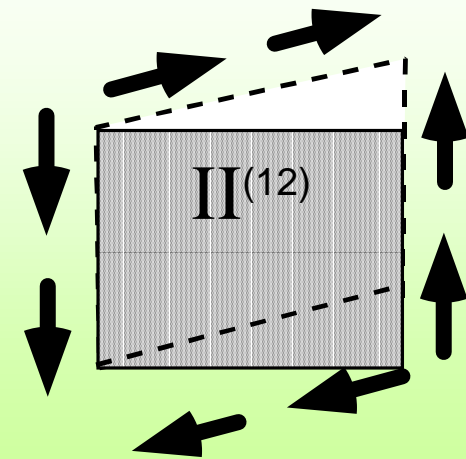
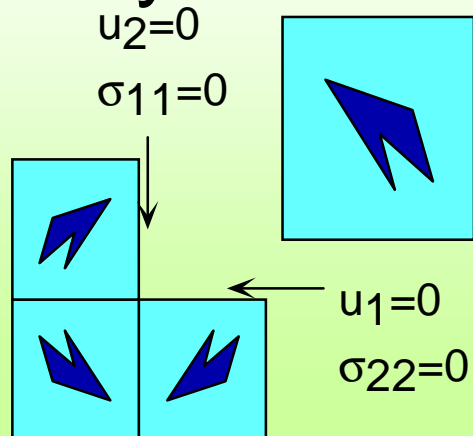

# Periodicity condition: elimination

- Reduce DOF by eliminating the DOF on the opposite side of the unit cell

$$\begin{array}{c}
 \begin{array}{c}
 \mathbf{R} \\
 \mathbf{S} \\
 \mathbf{T}
 \end{array}
 \begin{array}{c}
 v_1 \\
 v_2 \\
 v_3
 \end{array}
 \begin{array}{c}
 \mathbf{U} \\
 \mathbf{V} \\
 \mathbf{W}
 \end{array}
 \begin{array}{c}
 \mathbf{U}^T \\
 \mathbf{V}^T \\
 \mathbf{W}^T
 \end{array}
 \begin{array}{c}
 \mathbf{K}_{11} \\
 \mathbf{K}_{12}^T \\
 \mathbf{K}_{13}^T
 \end{array}
 \begin{array}{c}
 \mathbf{K}_{12} \\
 \mathbf{K}_{22} \\
 \mathbf{K}_{23}^T
 \end{array}
 \begin{array}{c}
 \mathbf{K}_{13} \\
 \mathbf{K}_{23} \\
 \mathbf{K}_{33}
 \end{array}
 \begin{array}{c}
 \mathbf{R} \\
 \mathbf{S} \\
 \mathbf{T}
 \end{array}
 \begin{array}{c}
 u_1 \\
 u_2 \\
 u_3
 \end{array}
 \begin{array}{c}
 \mathbf{U} \\
 \mathbf{V} \\
 \mathbf{W}
 \end{array}
 =
 \begin{array}{c}
 \mathbf{R} \\
 \mathbf{S} \\
 \mathbf{T}
 \end{array}
 \begin{array}{c}
 v_1 \\
 v_2 \\
 v_3
 \end{array}
 \begin{array}{c}
 \mathbf{U} \\
 \mathbf{V} \\
 \mathbf{W}
 \end{array}
 \begin{array}{c}
 \mathbf{U}^T \\
 \mathbf{V}^T \\
 \mathbf{W}^T
 \end{array}
 \begin{array}{c}
 \mathbf{R} \\
 \mathbf{S} \\
 \mathbf{T}
 \end{array}
 \begin{array}{c}
 f_1 \\
 f_2 \\
 f_3
 \end{array}
 \begin{array}{c}
 \mathbf{U} \\
 \mathbf{V} \\
 \mathbf{W}
 \end{array}
 \end{array}$$
  

$$\begin{array}{c}
 \mathbf{R} \\
 \mathbf{S} \\
 \mathbf{T}
 \end{array}
 \begin{array}{c}
 v_1 \\
 v_2 \\
 v_3
 \end{array}
 \begin{array}{c}
 \mathbf{U} \\
 \mathbf{V} \\
 \mathbf{W}
 \end{array}
 \begin{array}{c}
 \mathbf{U}^T \\
 \mathbf{V}^T \\
 \mathbf{W}^T
 \end{array}
 \begin{array}{c}
 \mathbf{K}_{11} \\
 \mathbf{K}_{12}^T + \mathbf{K}_{13}^T \\
 \mathbf{K}_{12}^T + \mathbf{K}_{23}^T + \mathbf{K}_{33}^T
 \end{array}
 \begin{array}{c}
 \mathbf{K}_{12} + \mathbf{K}_{13} \\
 \mathbf{K}_{22} + \mathbf{K}_{33} + \mathbf{K}_{23} \\
 \mathbf{K}_{23} + \mathbf{K}_{33} + \mathbf{K}_{23}^T
 \end{array}
 \begin{array}{c}
 \mathbf{R} \\
 \mathbf{S} \\
 \mathbf{T}
 \end{array}
 \begin{array}{c}
 u_1 \\
 u_2 \\
 u_2
 \end{array}
 \begin{array}{c}
 \mathbf{U} \\
 \mathbf{V} \\
 \mathbf{W}
 \end{array}
 =
 \begin{array}{c}
 \mathbf{R} \\
 \mathbf{S} \\
 \mathbf{T}
 \end{array}
 \begin{array}{c}
 v_1 \\
 v_2 \\
 v_2
 \end{array}
 \begin{array}{c}
 \mathbf{U} \\
 \mathbf{V} \\
 \mathbf{W}
 \end{array}
 \begin{array}{c}
 \mathbf{U}^T \\
 \mathbf{V}^T \\
 \mathbf{W}^T
 \end{array}
 \begin{array}{c}
 \mathbf{R} \\
 \mathbf{S} \\
 \mathbf{T}
 \end{array}
 \begin{array}{c}
 f_1 \\
 f_2 + f_3 \\
 f_2 + f_3
 \end{array}
 \begin{array}{c}
 \mathbf{U} \\
 \mathbf{V} \\
 \mathbf{W}
 \end{array}$$

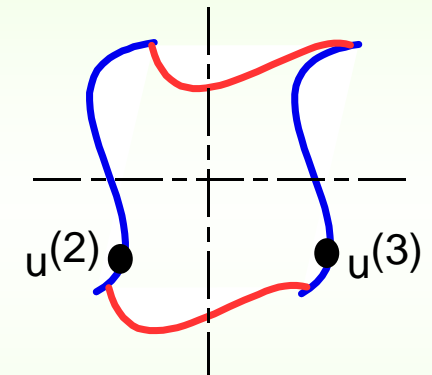



# Special case: homogeneous material

$$\int_Y \varepsilon \delta u f : L : \varepsilon \chi^{(pq)} h dY = \int_Y \varepsilon \delta u f : L : \Pi^{(kl)} dY$$

$$= \int_Y \varepsilon \delta u f : \underbrace{\begin{matrix} \lambda+2\mu & & \\ & \lambda & \\ & & 0 \end{matrix}}_{pq=11} \underbrace{\begin{matrix} & & \lambda \\ & \lambda+2\mu & \\ & & 0 \end{matrix}}_{pq=22} \underbrace{\begin{matrix} & & & \\ & & & \\ & & & \\ & & & \end{matrix}}_{pq=12} dY$$

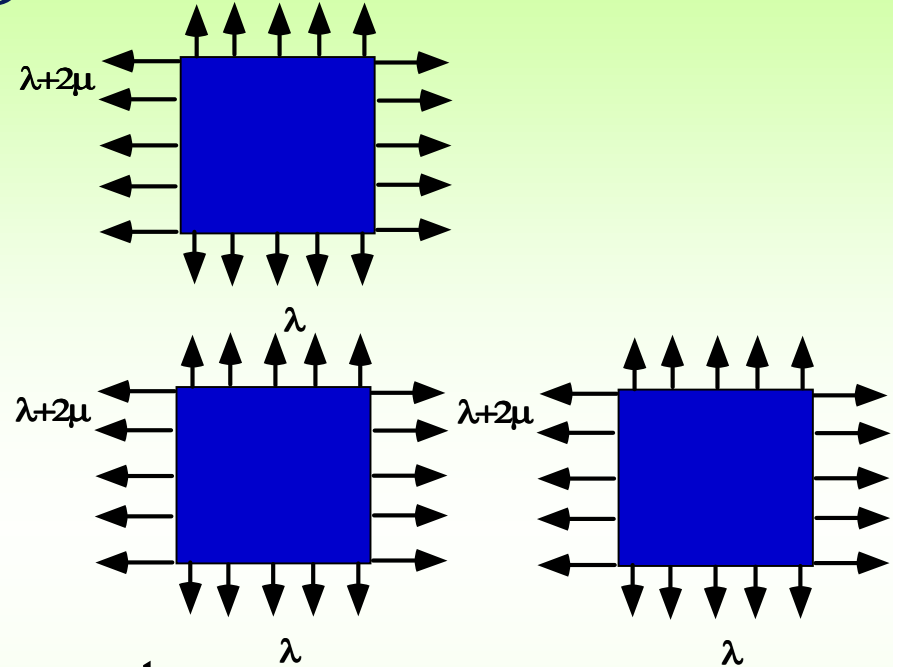

- Zero RHS;  $\chi^{pq}$ : zero vector

- Localization tensor:  $(\Pi^{pq} + \varepsilon(\chi^{pq})) = \Pi^{pq}$

$$E_{ijkl}^H = \left\langle \begin{matrix} \mathbb{F} \\ \mathbb{G} \\ \mathbb{H} \end{matrix} \Pi_{rs}^{(ij)} + \underbrace{\varepsilon_{rs} d\chi^{dijf}}_0 \begin{matrix} \mathbb{I} \\ \mathbb{J} \\ \mathbb{K} \end{matrix} E_{pqrs} \begin{matrix} \mathbb{F} \\ \mathbb{G} \\ \mathbb{H} \end{matrix} \Pi_{rs}^{(ij)} + \underbrace{\varepsilon_{pq} d\chi^{dklf}}_0 \begin{matrix} \mathbb{I} \\ \mathbb{J} \\ \mathbb{K} \end{matrix} \right\rangle = \langle E_{ijkl} \rangle = E_{ijkl}$$

# 2D Unit Cell Problem, 6 load cases

- Elastic Problem**

$$\int_Y L_{ijpq} \frac{\partial \chi_p^{(kl)}}{\partial y_q} \frac{\partial \delta u_i}{\partial y_j} = - \int_Y L_{ijkl} \frac{\partial \delta u_i}{\partial y_j} dY \quad \forall \delta u_i$$

Unit strain

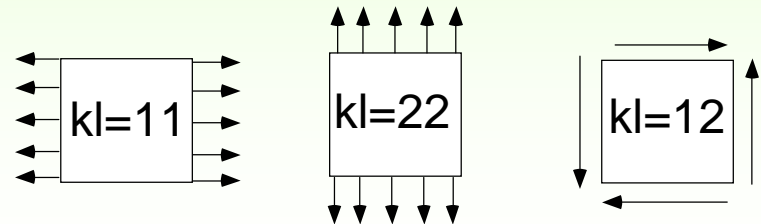

- Thermal-elastic Problem**

$$\int_Y L_{ijpq} \frac{\partial \phi_p}{\partial y_q} \frac{\partial \delta u_i}{\partial y_j} = - \int_Y \beta_{ij} \frac{\partial \delta u_i}{\partial y_j} dY \quad \forall \delta u_i$$



Unit temperature rise

- Conductivity Problem**

$$\int_Y \lambda_{ij} \frac{\partial \psi^{(k)}}{\partial y_i} \frac{\partial \delta T}{\partial y_j} = - \int_Y \lambda_{ik} \frac{\partial \delta T}{\partial y_i} dY \quad \forall \delta T$$

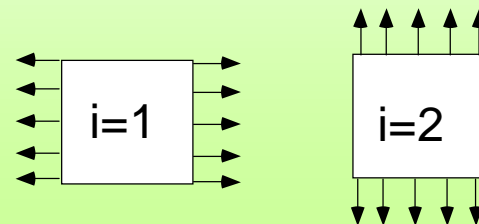

Unit heat flux

# Homogenization of thermoelastic & conductivity

- Homogenized thermoelastic and conductivity properties

$$L^H = \frac{1}{Y} \int_Y \mathbf{a} \mathbb{I} + \varepsilon(\chi) \mathbf{f} : L : \mathbf{a} \mathbb{I} + \varepsilon(\chi) \mathbf{f} dY$$

$$\beta^H = \frac{1}{Y} \int_Y \mathbf{a} \beta + \beta : \varepsilon(\phi) \mathbf{f} dY$$

$$\lambda^H = \frac{1}{Y} \int_Y \mathbf{a} \mathbb{I} + \nabla \psi \mathbf{f} \cdot \lambda \cdot \mathbf{a} \mathbb{I} + \nabla \psi \mathbf{f} dY$$

- Unit cell problems

$$\int_Y \mathbf{b} \varepsilon(\delta u_1) \mathbf{g} L : \mathbf{a} \mathbb{I} + \varepsilon(\chi) \mathbf{f} dY = 0 \quad \forall \delta u_1$$

$$\int_Y \mathbf{b} \varepsilon(\delta u_1) \mathbf{g} \mathbf{a} L : \varepsilon(\phi) + \beta \Delta T \mathbf{f} dY = 0 \quad \forall \delta u_1$$

$$\int_Y \mathbf{a} \nabla \delta T \mathbf{f} \cdot \lambda \cdot \mathbf{a} \mathbb{I} + \nabla \psi \mathbf{f} dY = 0 \quad \forall \delta T$$

Unit Cell

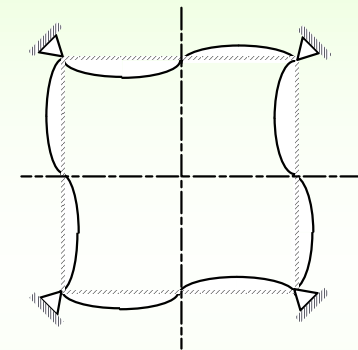

periodicity  
conditions  
enforced  
in the unit  
cell

# Simply Examples: Layered Materials

# Homogenization of layered material

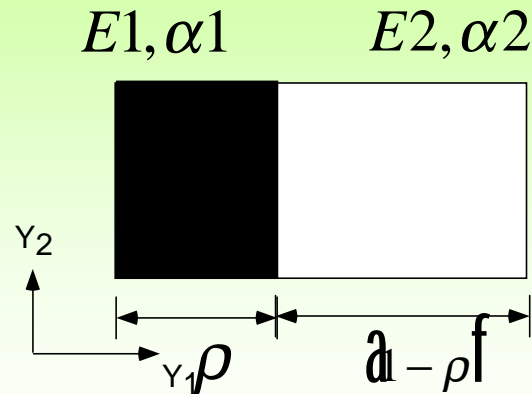

- Layered along  $y_1$ ,  $\frac{\partial \chi}{\partial y_2} = 0$

$$\frac{\partial}{\partial y_1} L_{i1kl} \delta_{kp} \delta_{lq} + \frac{\partial \chi_k^{pq}}{\partial y_l} = 0$$

- Layered material is orthotropic

$$L_{1112} = L_{2212} = L_{1211} = L_{1222} = 0$$

$$L_{1111} \delta_{1p} \delta_{1q} + \chi_{1,1}^{pq} = C_1^{(pq)}$$

$$L_{1212} \delta_{1p} \delta_{2q} + L_{1212} \chi_{2,1}^{pq} + \delta_{2p} \delta_{1q} = C_2^{(pq)}$$

# Homogenization Results

$$\mathbf{L}^H = \left\langle \frac{1}{\mathbf{L}_{1111}} \right\rangle^{-1} \left\langle \frac{\mathbf{L}_{1122}}{\mathbf{L}_{1111}} \right\rangle \left\langle \frac{1}{\mathbf{L}_{1111}} \right\rangle^{-1} \begin{pmatrix} 0 \\ 0 \\ \left\langle \frac{1}{\mathbf{L}_{1212}} \right\rangle^{-1} \end{pmatrix} + \left\langle \mathbf{L}_{2222} \right\rangle - \left\langle \frac{\mathbf{L}_{1122}^2}{\mathbf{L}_{1111}} \right\rangle + \left\langle \frac{\mathbf{L}_{1122}}{\mathbf{L}_{1111}} \right\rangle^2 \left\langle \frac{1}{\mathbf{L}_{1111}} \right\rangle^{-1}$$

$$\boldsymbol{\beta}^H = \left\langle \frac{\beta_{11}}{\mathbf{L}_{1111}} \right\rangle \left\langle \frac{1}{\mathbf{L}_{1111}} \right\rangle^{-1} \begin{pmatrix} 0 \\ \left\langle \beta_{22} - \frac{\mathbf{L}_{2211}}{\mathbf{L}_{1111}} \beta_{11} - \left\langle \frac{\beta_{11}}{\mathbf{L}_{1111}} \right\rangle \left\langle \frac{1}{\mathbf{L}_{1111}} \right\rangle^{-1} \right\rangle^{-1} \begin{pmatrix} 0 \\ 0 \\ \left\langle \frac{1}{\mathbf{L}_{1212}} \right\rangle^{-1} \end{pmatrix}$$

# Homogenization Results

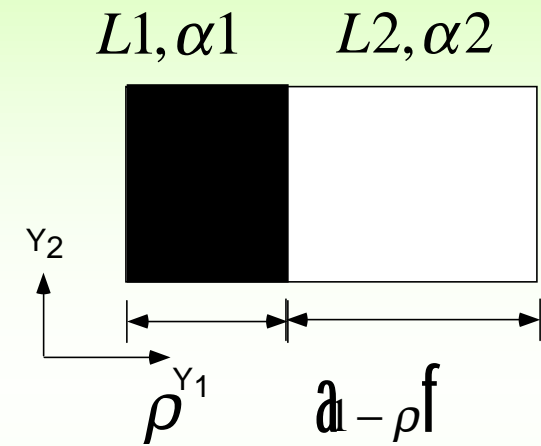
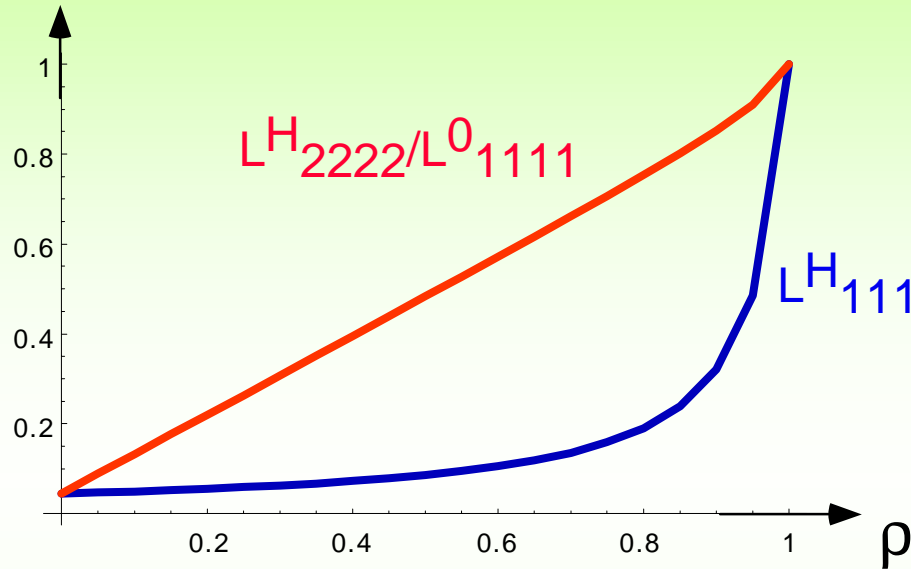

$$\frac{L1}{L2} = \frac{22}{1},$$

$$\frac{\alpha1}{\alpha2} = \frac{1}{12}$$

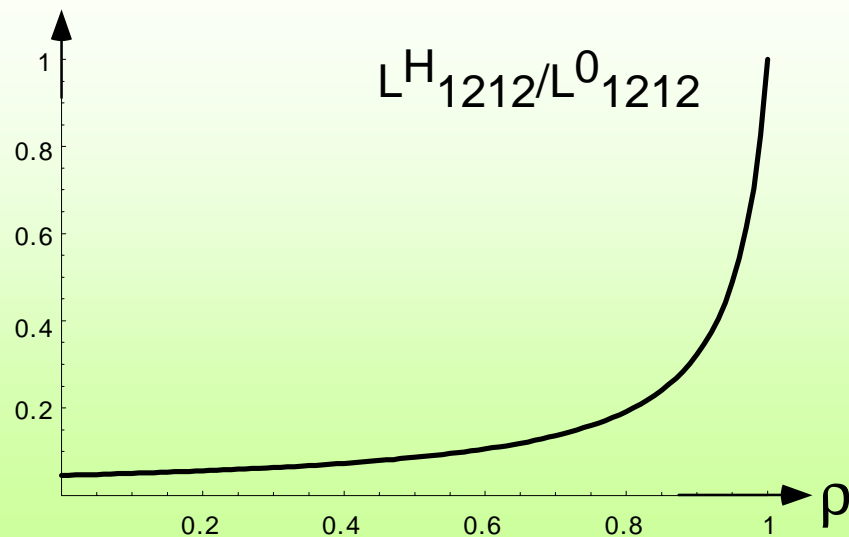

# Red + Yellow $\neq$ Orange

Adding the CTE is *not* like adding paints

- Levin's example, 1967
- The effective CTE does not form a convex set
- Unusual CTE occurs when  $\rho < 0.2$

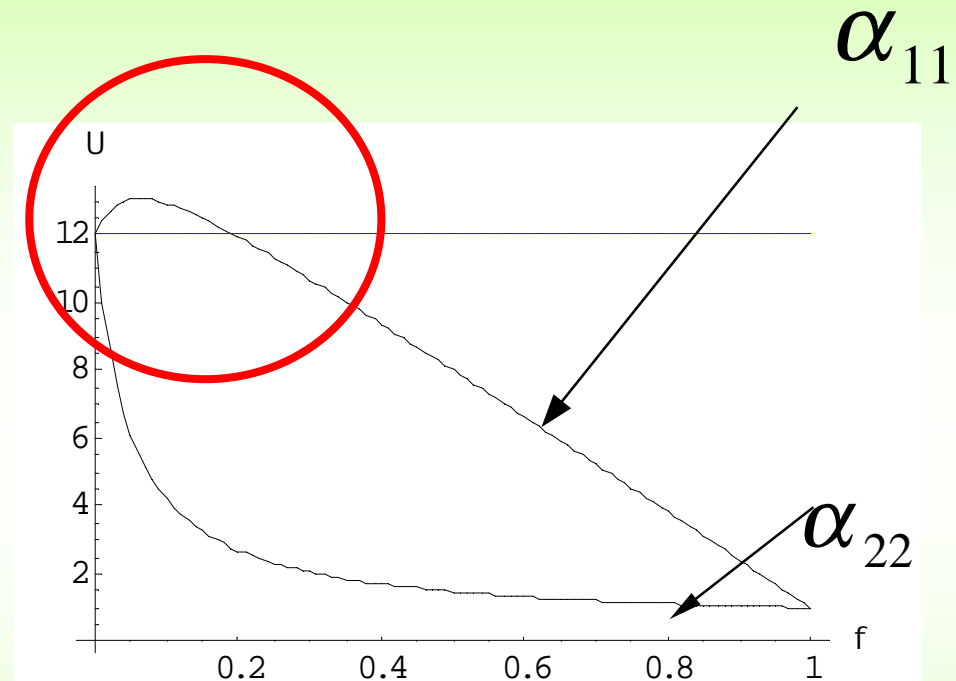

$$\frac{L1}{L2} = \frac{22}{1},$$

$$\frac{\alpha 1}{\alpha 2} = \frac{1}{12}$$

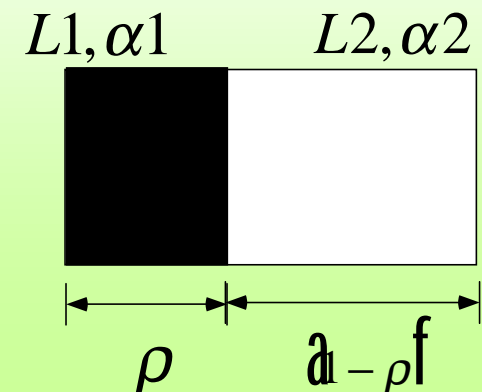



# Summary

- A problem with highly oscillating coefficients can be solved by global-local analysis
- Local analysis: characteristic displacement of the unit cell, find *homogenized coefficient*
- Global analysis: the original domain is treated as if homogeneous to find the stress/strain distribution
- Localization process: given the find the local stress distribution within the unit cell