



**Slow Velocity Flow Fields
in Composite Materials**
A Coupled Problem
by the Homogenization Method

Noboru Kikuchi

and

His Associates

The University of Michigan

Ann Arbor, MI 48109, USA



Major Contributors

- **Dr. Chang Whie**
 - Samsung Motor Corporation, Korea
 - Resin Transfer Molding (RTM) Simulation
- **Drs. Kenjiro Terada and T. Ito**
 - Tohoku University and Toyota College of Technology, Japan
 - Bio's Equation for Consolidation by the Homogenization Method
- **Dr. S.W. Hsiao**
 - Hon Hai Precision Industry, Taiwan
 - Thermoplastic Molding Simulation by the Homogenization Method
- **Ms. Minako Sekiguchi**
 - Nissan Motor Corporation, Japan
 - Image Based CAE Approach for Modeling and Analysis



Major Objective

- **Establishment of a Material Processing Simulation Method Involving Microstructure and Slow Velocity Fluid Flow with Heat Conduction/Transfer**
- **Manufacturing : Computer Aided Production Engineering (CAPE)**
- **Microstructure (or Mesostructure) : Application of the Homogenization Method**
- **Coupled Problem : Solid and Fluid with Heat Transfer**
- **Large Scale Computating**



R&D History

- **1st US-Japan Symposium**

- **Resin Transfer Molding (RTM) Simulation with**

- the Homogenization Method with Multiple Level Microstructures
 - the Adaptive Remeshing Finite Element Method
 - Stokes Flow in Microstructure and Darcy's Flow in Macroscopic Domain

- **2nd US-Japan Symposium**

- **Resin Transfer Molding Simulation with Curing Process**

- Extension of the RTM Simulation to fully 3-Dimensional Setting
 - Addition of Curing Processes : Prediction of Residual Strains and Stresses

- **3rd US-Japan Symposium**

- **Coupled Problems with Flow and Solid in the Microstructure**

- Solids (Pre-form, Porous Media, Bones, etc) are now Deformable
 - Small Viscosity Fluids --- Bio's Consolidation Theory
 - Large Viscosity Fluids --- Visco- elasticity Theory



Chan Whie, TE Tezduyar, and N. Kikuchi University of Minnesota and University of Michigan

Resin Transfer Molding Simulation

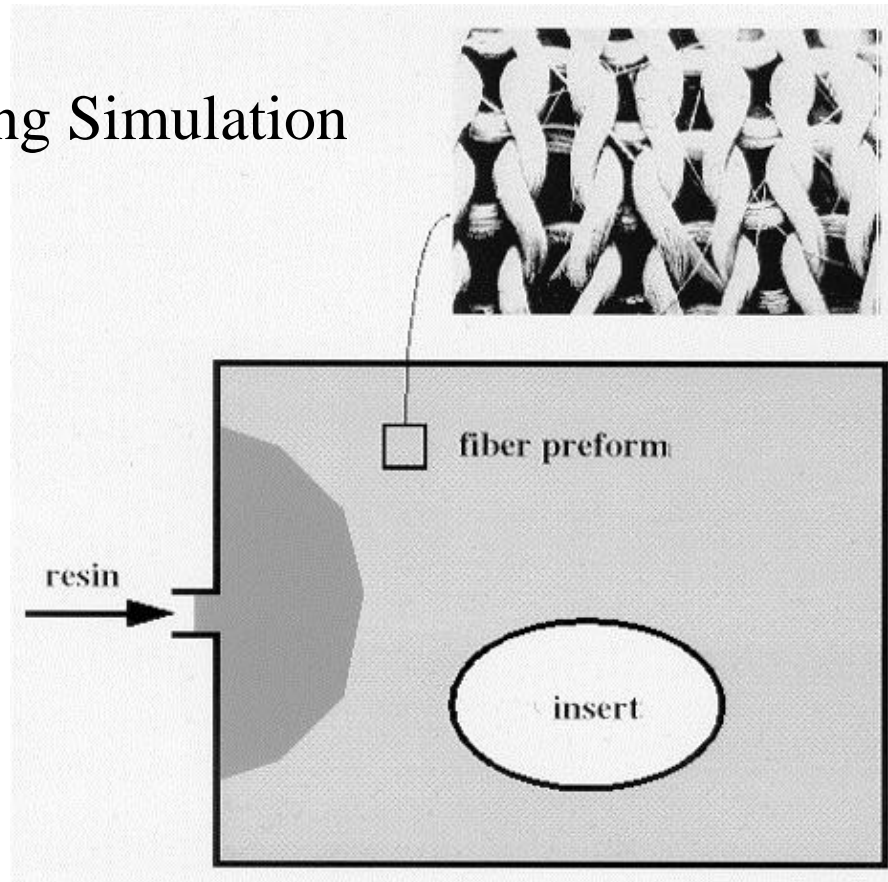



Resin

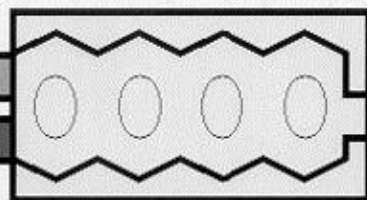

Static Mixer

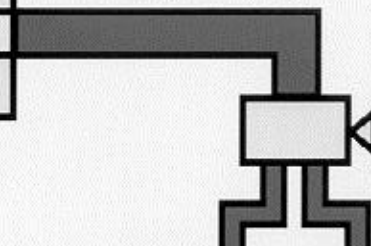

Top Mold Assembly

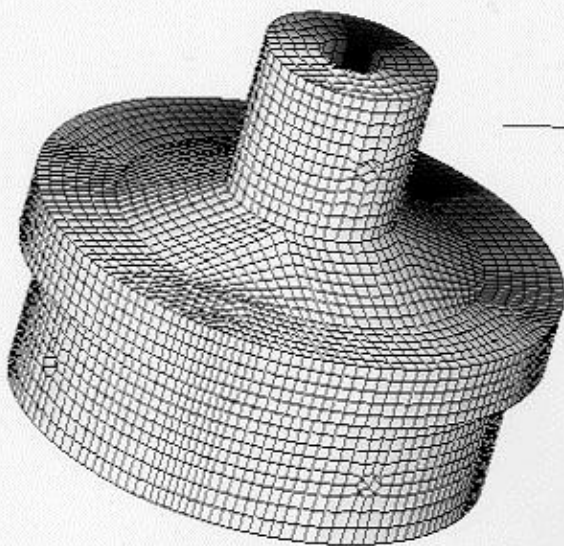

Fiber Preform

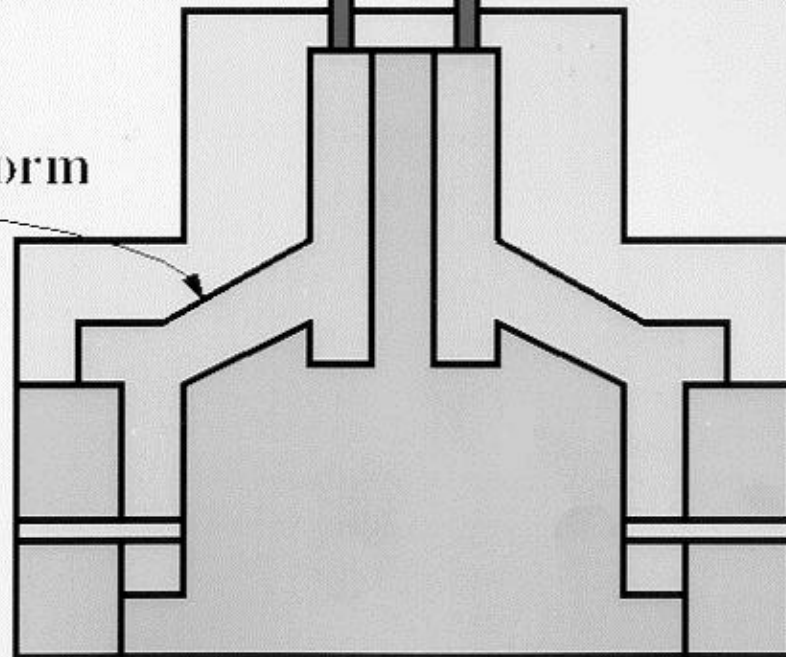

Bottom Mold Assembly



Filling Process of Resin into Pre-form Mat

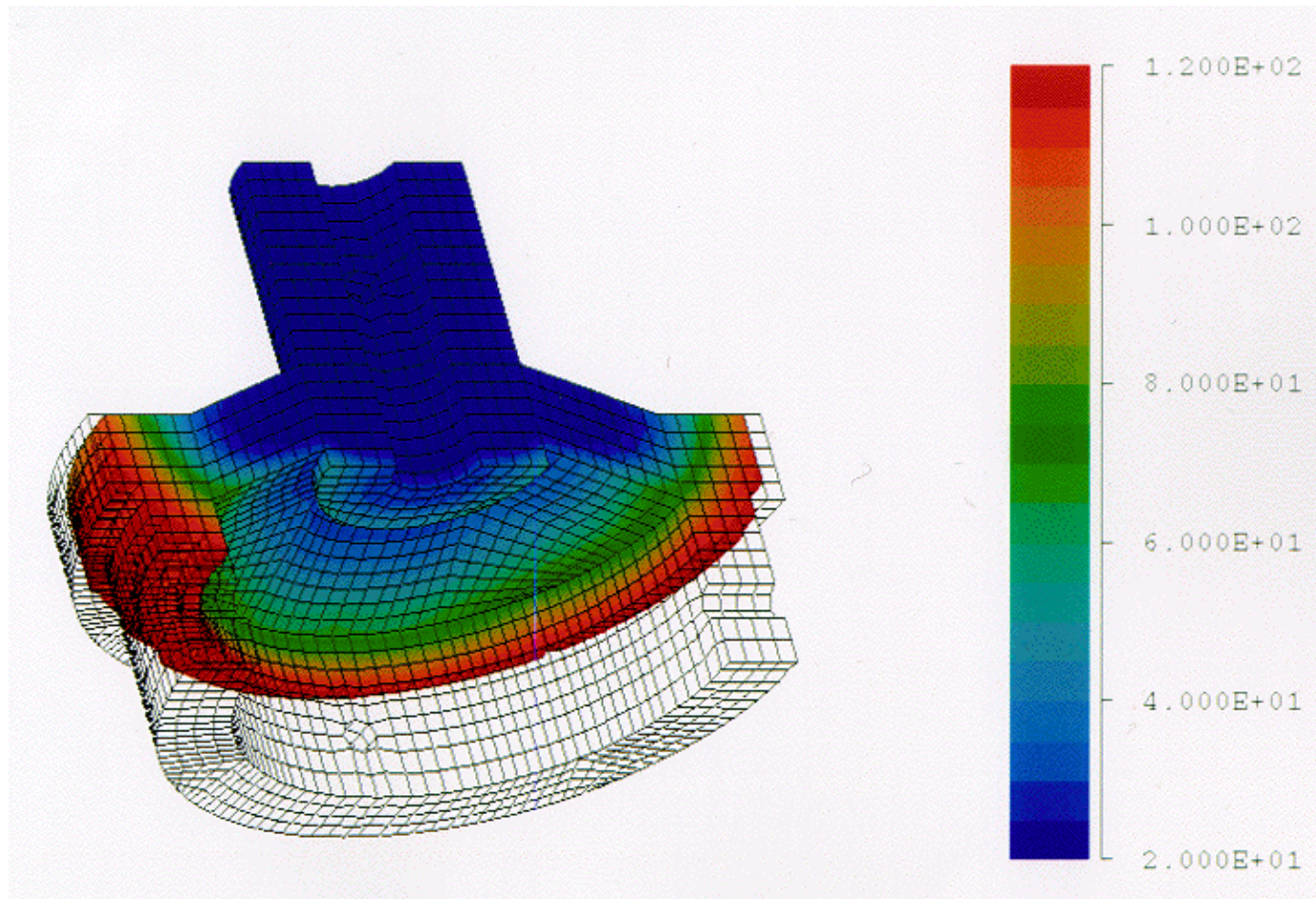



K. Terada and T. Ito

Tohoku University & Toyota College of Technology

Biot's Consolidation Equation & Seepage Flow

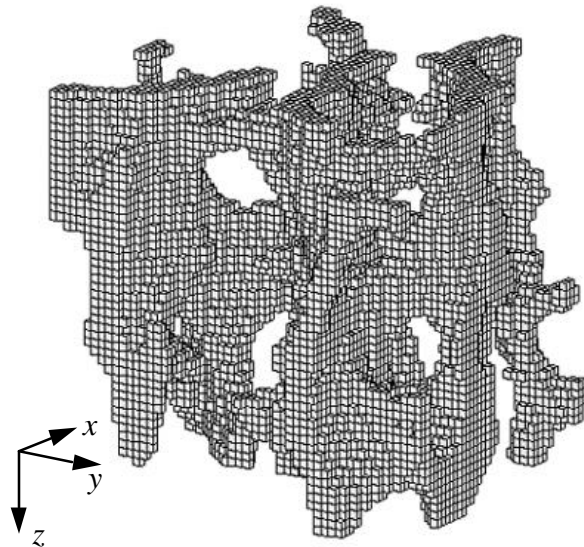

(a) fluid phase

$$\mathbf{K}^H = \begin{bmatrix} 0 & 0 & 0 \\ \text{sym.} & 1.861 & 0.1533 \\ & & 1.903 \end{bmatrix} (m^4/N \cdot s)$$

$$\mathbf{Q}^H = \begin{bmatrix} -0.3499 & 0.0139 & -0.009678 \\ \text{sym.} & -0.3786 & 0.01094 \\ & & 0.2512 \end{bmatrix}$$

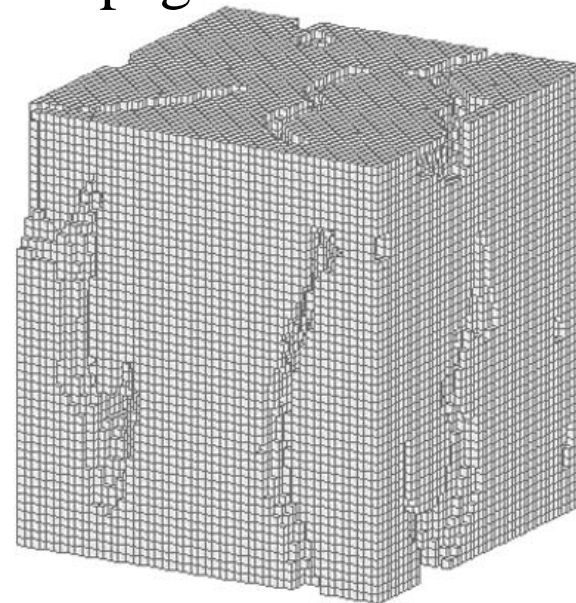

(b) solid phase

$$\mathbf{E}^H = \begin{bmatrix} 304 & 106 & 122 & 1.88 & -3.55 & 5.43 \\ & 282 & 114 & 3.40 & -1.10 & 5.71 \\ & & 394 & 5.65 & -5.03 & 2.79 \\ & & & 106 & 2.29 & -1.132 \\ \text{sym.} & & & & 110 & 1.60 \\ & & & & & 99.4 \end{bmatrix} \text{MPa}$$



Stress Field in the Microstructure

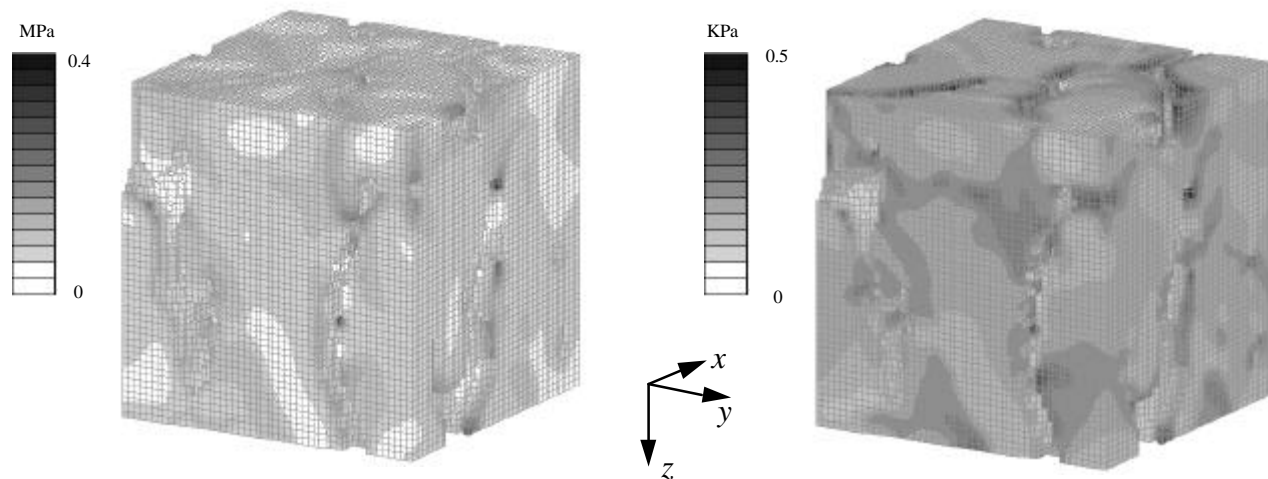

(a) pressurized without strain (case 1)

(b) strained without pressure (case 2)

$$e = \begin{bmatrix} 0 & 0 & 0 \\ & 0 & 0 \\ \text{sym.} & & 0 \end{bmatrix}; p = 100 \text{ MPa}; \frac{\partial p}{\partial y} = 1.0 \times 10^{-4}, \frac{\partial p}{\partial x} = \frac{\partial p}{\partial z} = 0.0 \text{ N/m}^3$$

$$e = \begin{bmatrix} 0 & 0 & 0 \\ & 5.0 & 0.5 \\ \text{sym.} & & 5.0 \end{bmatrix} \times 10^{-4}; p = 0 \text{ MPa}; \frac{\partial p}{\partial y} = \frac{\partial p}{\partial z} = 0.5 \times 10^{-4}, \frac{\partial p}{\partial x} = 0.0 \text{ N/m}^3$$



Flow Fields in the Microstructure

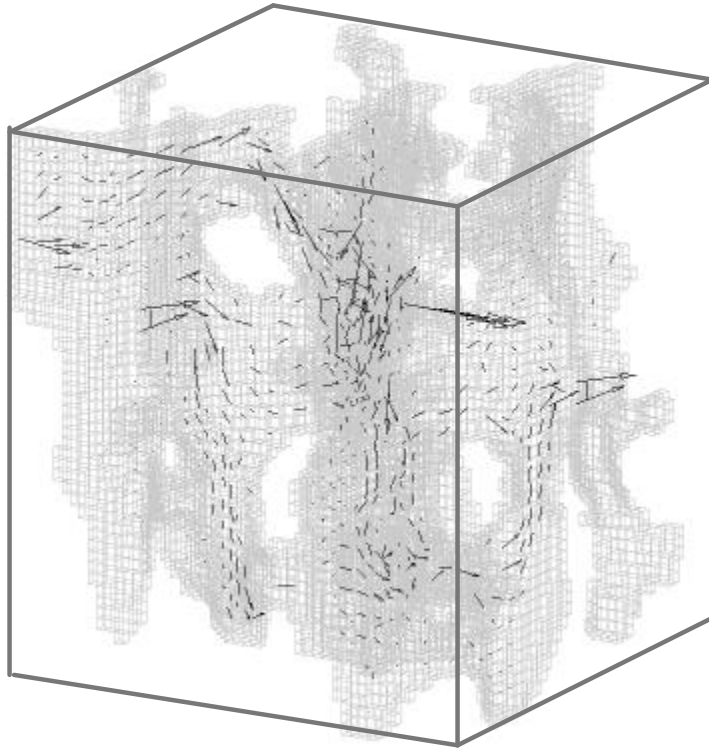

(a) $-\nabla p = \{0 \quad 1 \quad 0\}^T \times 10^{-4} \text{ N/m}^3$

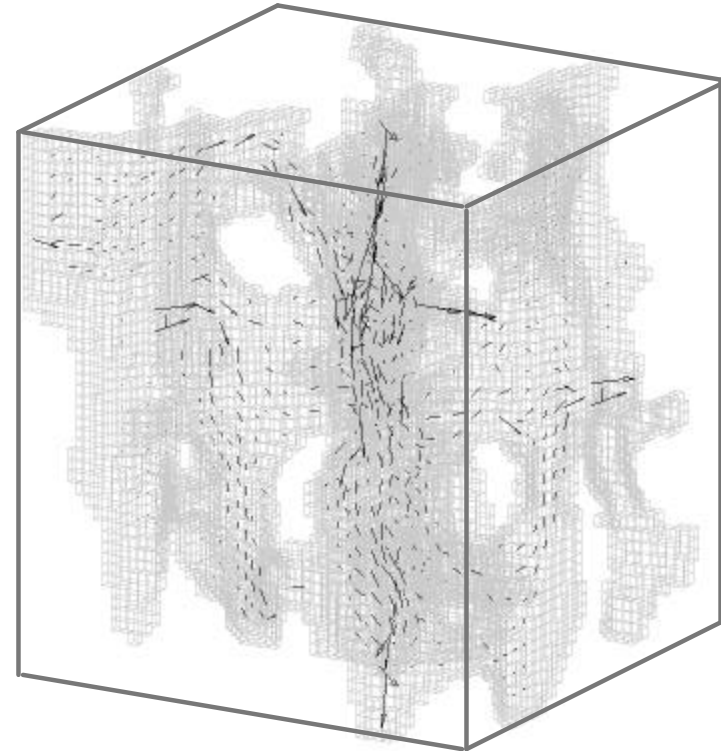

(b) $-\nabla p = \{0 \quad 0.5 \quad 0.5\}^T \times 10^{-4} \text{ N/m}^3$

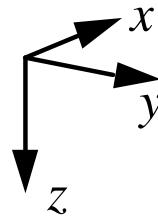



K. Terada and T. Watanabe Tohoku University

Permeability Prediction by the Homogenization Method
Flow Simulation Through Porous Crashed Rock Fields



100x80x100

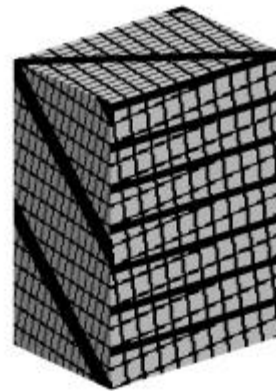

100x70x140

Darcy's Law

$$V_{ik} = -K_{ik} \frac{\partial P}{\partial x_k}$$

$$\mathbf{K}'_1 = \begin{pmatrix} 8.7 \times 10^{-12} & -9.7 \times 10^{-14} & -5.8 \times 10^{-13} \\ \text{sym.} & 1.4 \times 10^{-11} & -1.1 \times 10^{-13} \\ & & 1.4 \times 10^{-11} \end{pmatrix} \quad (\text{m}^4 / \text{N} \cdot \text{s})$$



Global-Local Flow Analysis : Seepage Flow

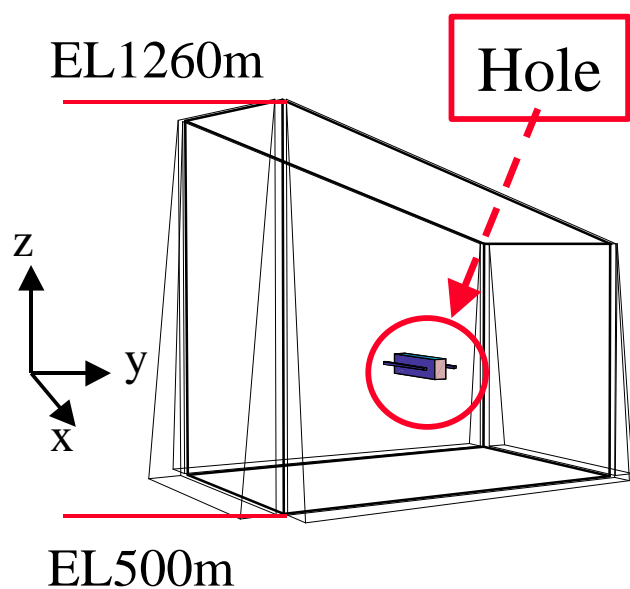

Analysis Domain
of Porous Rock
Field with a Hole

Pressure Distribution around a Hole

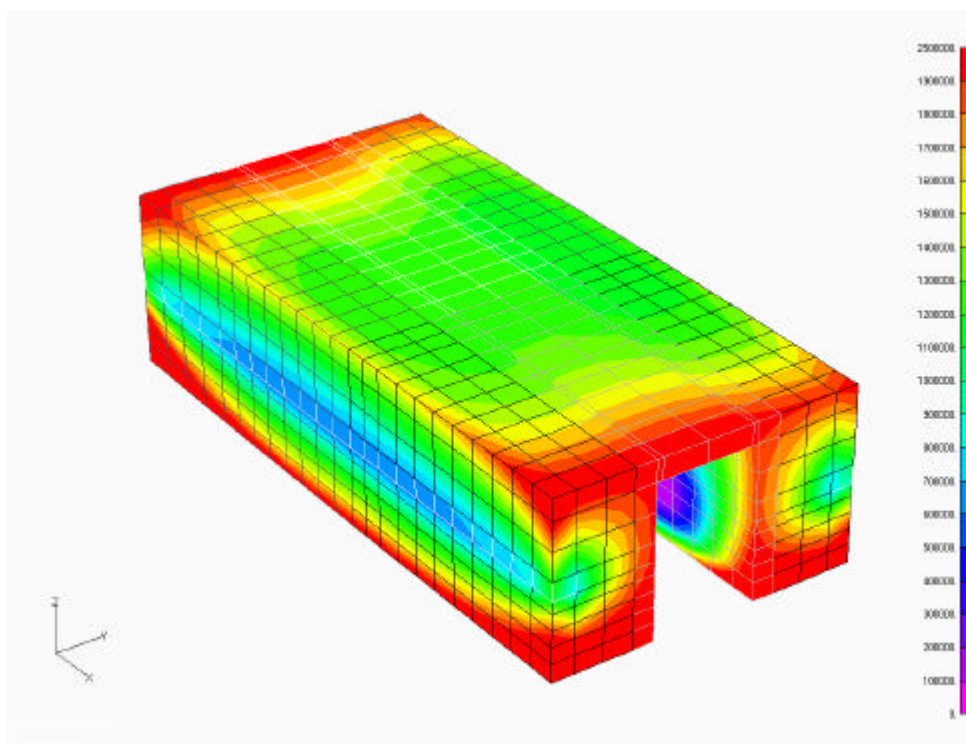

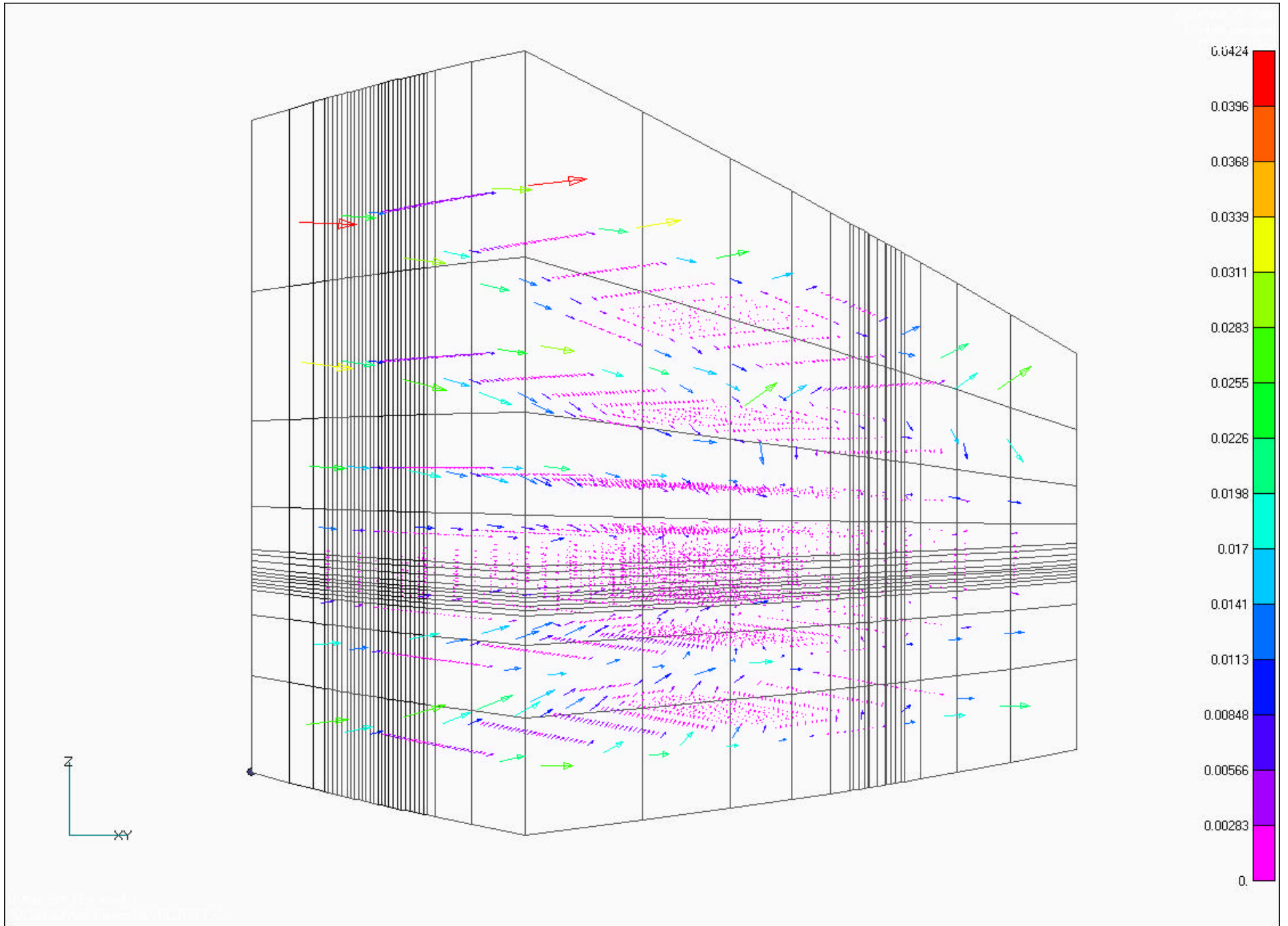



4th US-Japan Symposium

- **Manufacturing by RTM to Material Processing**

製造から加工

-
- **Material Processing : Forming Operation of a Composite Laminates made by RTM Processes**
 - **“Large Solid Deformation” due to thermo-molding process is simulated by “Slow Velocity Fluid Flow”**



Composite Thermoforming Process

S.W. Hsiao

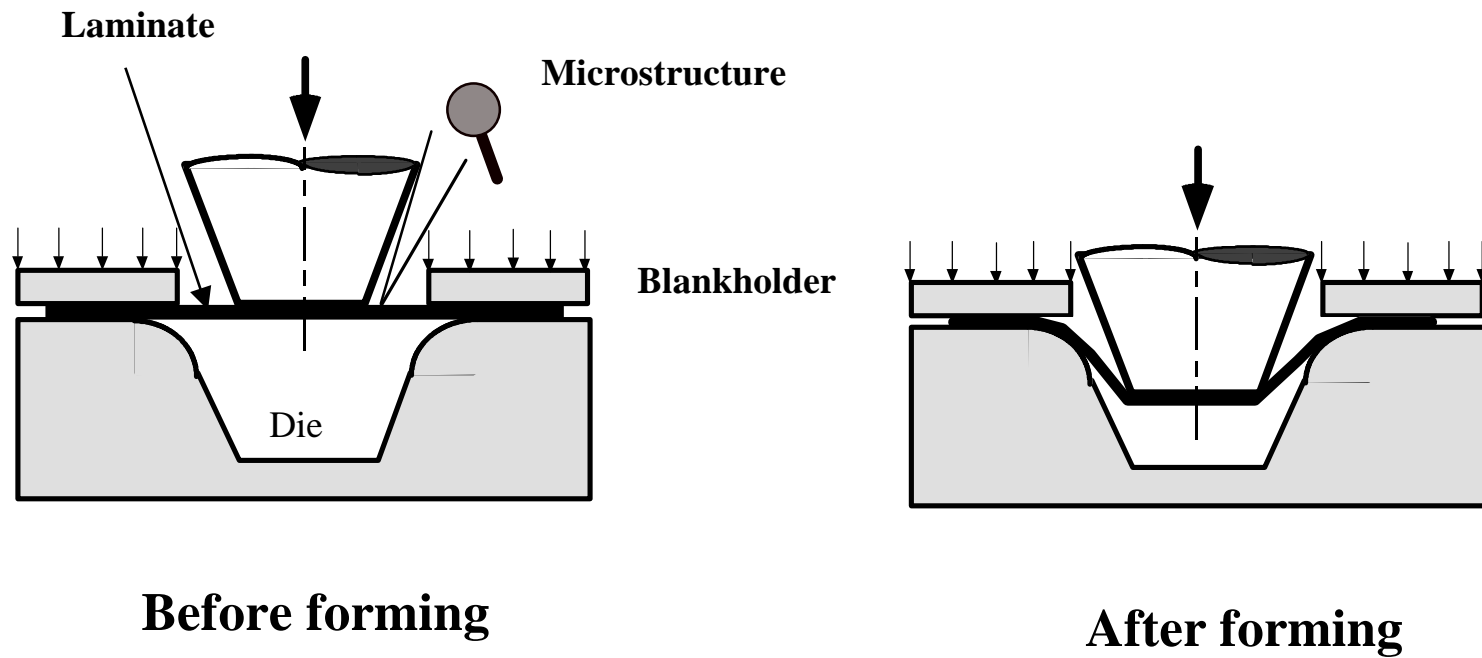



Motivations of this research

Deep drawing (stamping) of woven-fabric thermoplastic composites is a mass production and precision shaping technology to produce composite components.

Objectives of this research

- **Develop a FEM model to analyze this thermoforming process.**
- **Develop an optimization algorithm based on this FEM model to optimize this forming process.**



Polymeric Resin Materials

- **Thermosetting Resins, e.g. Epoxy**
 - **Cross-linked molecular chain**
 - **Brittle, sensitive to water**
 - **Low viscosity**
- **Thermoplastic Resins, e.g. polyetheretherketone (PEEK)**
 - **Linear molecular chain with temporary cross-link**
 - **Toughness, water and environmental resistance**
 - **High viscosity 100~1000 Pa.s**



Why Thermoplastic Composites?

From the manufacturing viewpoints

- **Thermosetting Resins**

- Hand layed up into structural fiber preform and impregnation after shaping
- Need chemical additives to cure after shaping and very long cure cycle time
- Labor intense

- **Thermoplastic Resins**

- Shaping only depends on heat transfer and force without chemistry
- In a preimpregnated continuous tape form
- High processing rate
- Drawback: higher processing viscosity and forming temperature (320~400 C), and higher equipment cost



Advantages of the composite stamping process

- ◆ **Deep drawing (stamping) of woven-fabric thermoplastic composites is a mass production technology to produce composite components.**
- ◆ **This stamping process is also a precision shaping process.**
- ◆ **Woven-fabric composites possess a balanced drawability, and can avoid the excessive thinning caused by the transverse intraply shearing.**



Governing equations for thermoforming process

1. Momentum and continuity equations

$$\frac{\partial \sigma_{ij}^\varepsilon}{\partial x_j} + f_i^\varepsilon = 0, \quad \frac{\partial v_i^\varepsilon}{\partial x_i} = 0$$

$$\text{with } \sigma_{ij}^\varepsilon = -P^\varepsilon \delta_{ij} + \mu^\varepsilon D_{ijkl} \dot{\varepsilon}_{ij}^\varepsilon$$

ε : Representing material heterogeneity of composites

2. Thermal equation

$$\rho c_p \frac{\partial T^\varepsilon}{\partial t} = \frac{\partial}{\partial x_j} \left(\frac{\kappa_{ij}}{L} \frac{\partial T^\varepsilon}{\partial x_i} \right) + R^\varepsilon$$

3. Viscosity equation

$$\mu^\varepsilon = C e^{\frac{b}{T^\varepsilon}} \left(\dot{\varepsilon}_{ij}^\varepsilon \right)^{(m-1)}$$



Assumptions for thermoforming process

- **Instantaneously rigid solid fibers suspended in an incompressible viscous matrix fluid at the high forming temperature.**
- **Fiber intersection angle changed by the macroscopic flow motion.**
- **Fiber in-extensibility for continuous fiber composites forming.**



Flow rheology of continuous fiber composites

Constitutive equation for continuous fiber composites

$$\sigma_{ij}^H = -P\delta_{ij} + F_{ij} + \mu^0 D_{ijkl}^H \varepsilon_{kl}^x$$

where F_{ij} is the large fiber tension in the fiber direction.

D_{ijkl}^H is the homogenized flow coefficient from local solutions.

Axial shearing viscosity

$$\mu_a^c = D_{1212}^H \mu^0$$

Transverse shearing viscosity

$$\mu_t^c = D_{2323}^H \mu^0$$



Homogenized governing equations for thermofoming process

⇒ Forming analysis

$$\int_{\Omega} \dot{\mu}^0 D_{ijkl}^H e_{kl}^x \frac{\partial w_i}{\partial x_j} d\Omega + \int_{\Omega} \dot{F}_{ij} \frac{\partial w_i}{\partial x_j} d\Omega = \int_{\Omega} \dot{\frac{\partial P}{\partial x_i}} w_i d\Omega + \int_{\Gamma} \dot{f}_i w_i d\Gamma$$

Homogenized flow coefficients

Large fiber tension due to fiber inextensibility

⇒ Thermal analysis

$$\int_{\Omega} \dot{(\rho c_p)}^H \frac{\partial T^0}{\partial t} \tau d\Omega + \int_{\Omega} \dot{K}_{ij}^H \frac{\partial T^0}{\partial x_i} \frac{\partial \tau}{\partial x_j} d\Omega = \int_{\Omega} \dot{R}^H \tau d\Omega + \dot{Q}$$

Homogenized conductivity coefficients



Digitized woven-fabric unit cell

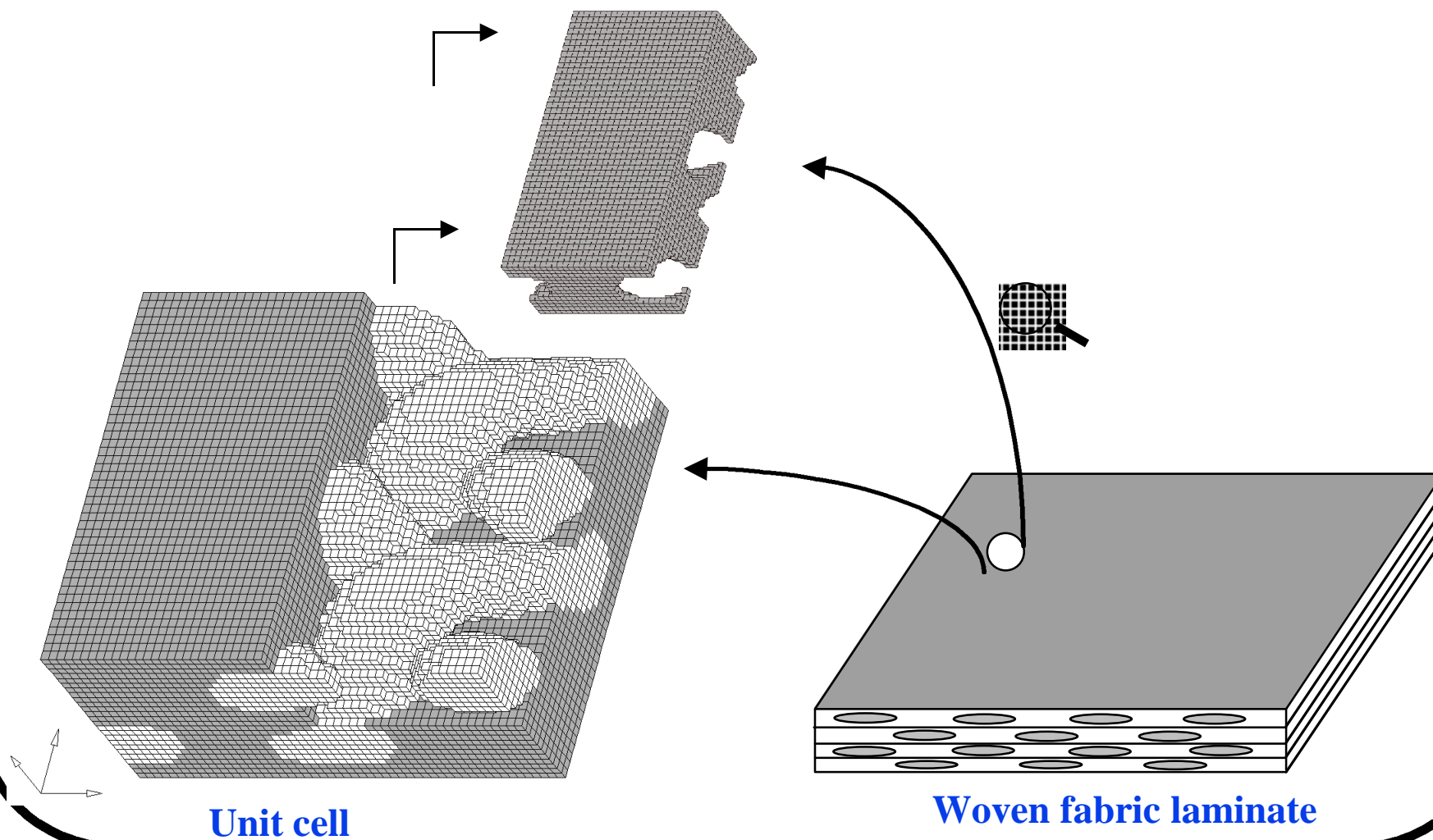

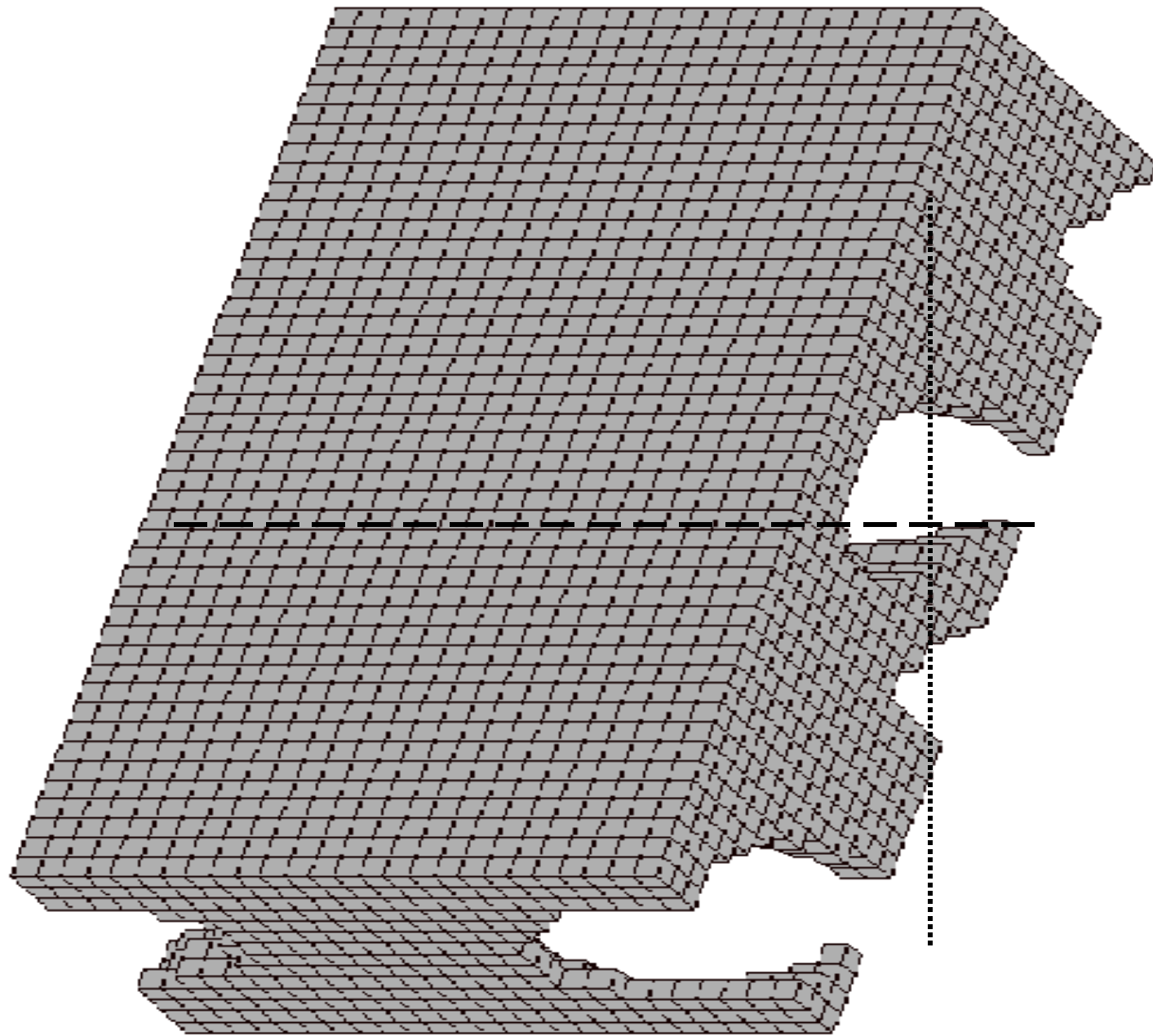



Thermal conductivity prediction for unidirectional composites vs volume fraction

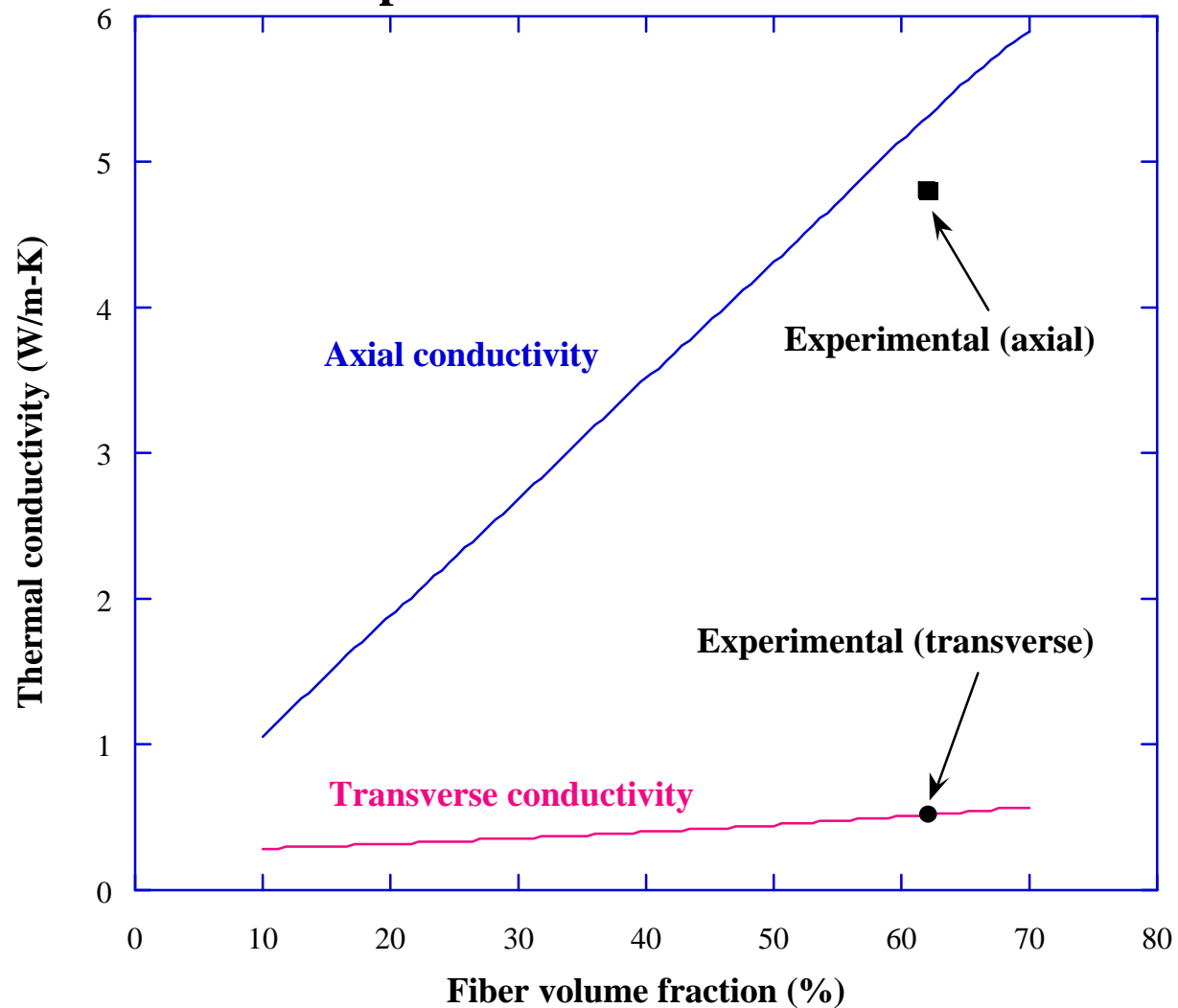



Implementation of Global FEA

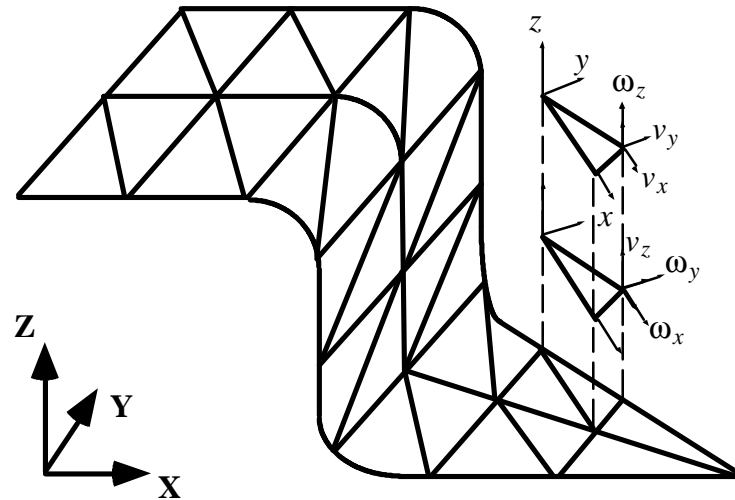

Membrane element

+

Bending element

||

Shell element

- **3-D sheet forming FE analysis coupled with heat transfer FE analysis using ‘Viscous shell with thermal analysis’.**



Viscous shell with thermal analysis

Viscous shell

- **Plane stress assumption-- the incompressibility constraint can be achieved by adjusting the thickness of each shell element.**
- **Large deformation process divided into a series of small time step.**
- **Complicated geometry, friction and contact considerations.**

Coupled thermal analysis

- **Transient heat transfer FEM to solve temperature at each node.**

At *i-th* time step $\underline{v}^{(i)}$ fi $\frac{\underline{X}^{(i)}}{\varepsilon} \hat{U} \mu^{(i)} \hat{U} T^{(i)}$ are solved.

- **At each step, solve nodal temperature and velocity iteratively until convergence.**



Fiber Orientation Model

Purposes:

- **Update the fiber intersection angle of each global finite element by the global strain increment at every time step.**
- **Change material properties according to updated fiber orientation.**

Assumptions:

- **The fiber orientation of all the microstructures in one global finite element is identical.**
- **The warp yarn and weft yarn of woven-fabric composites can be represented by two unit fiber vectors.**



Schematic of lamina coordinate

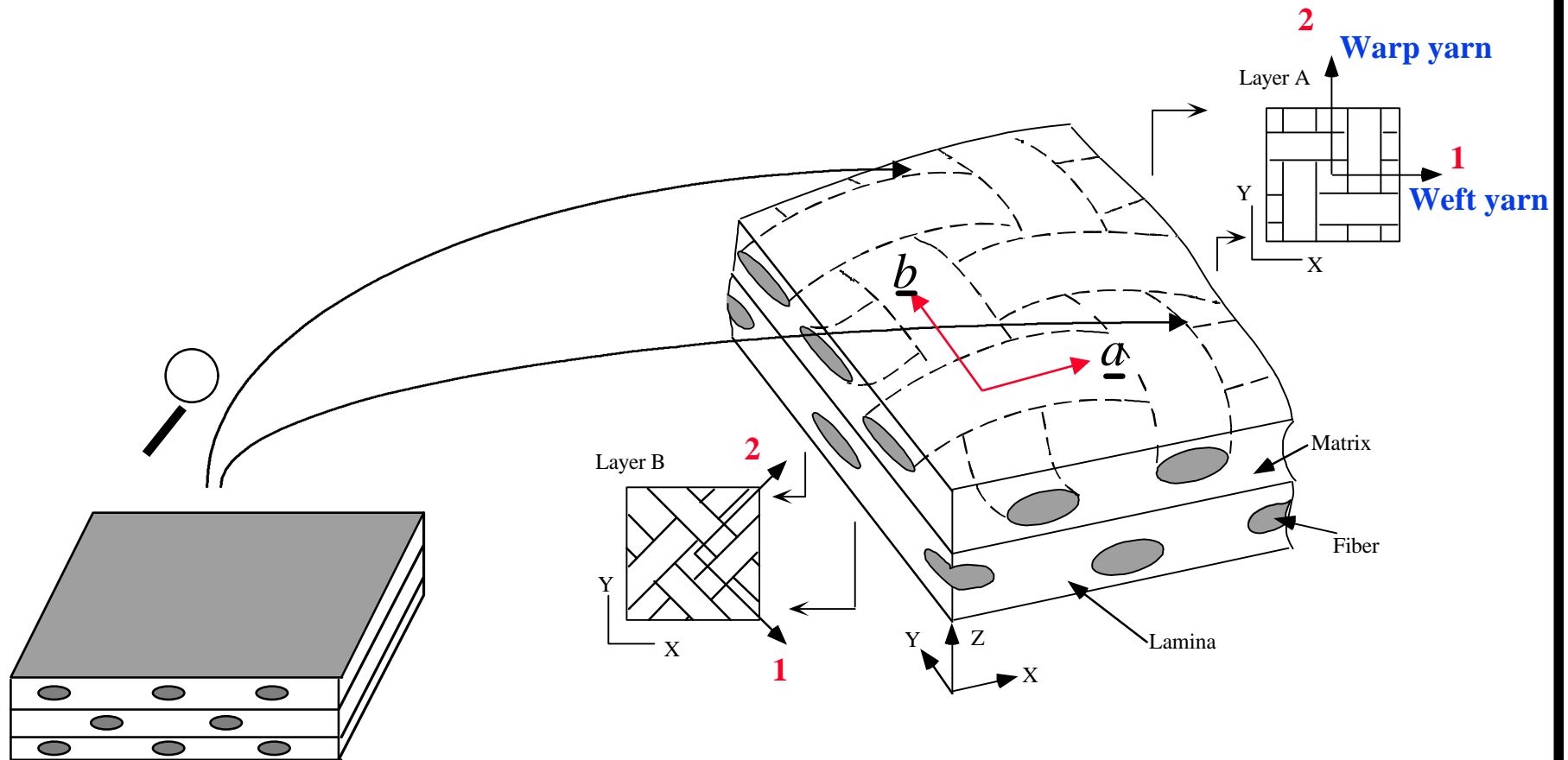



Updating Scheme

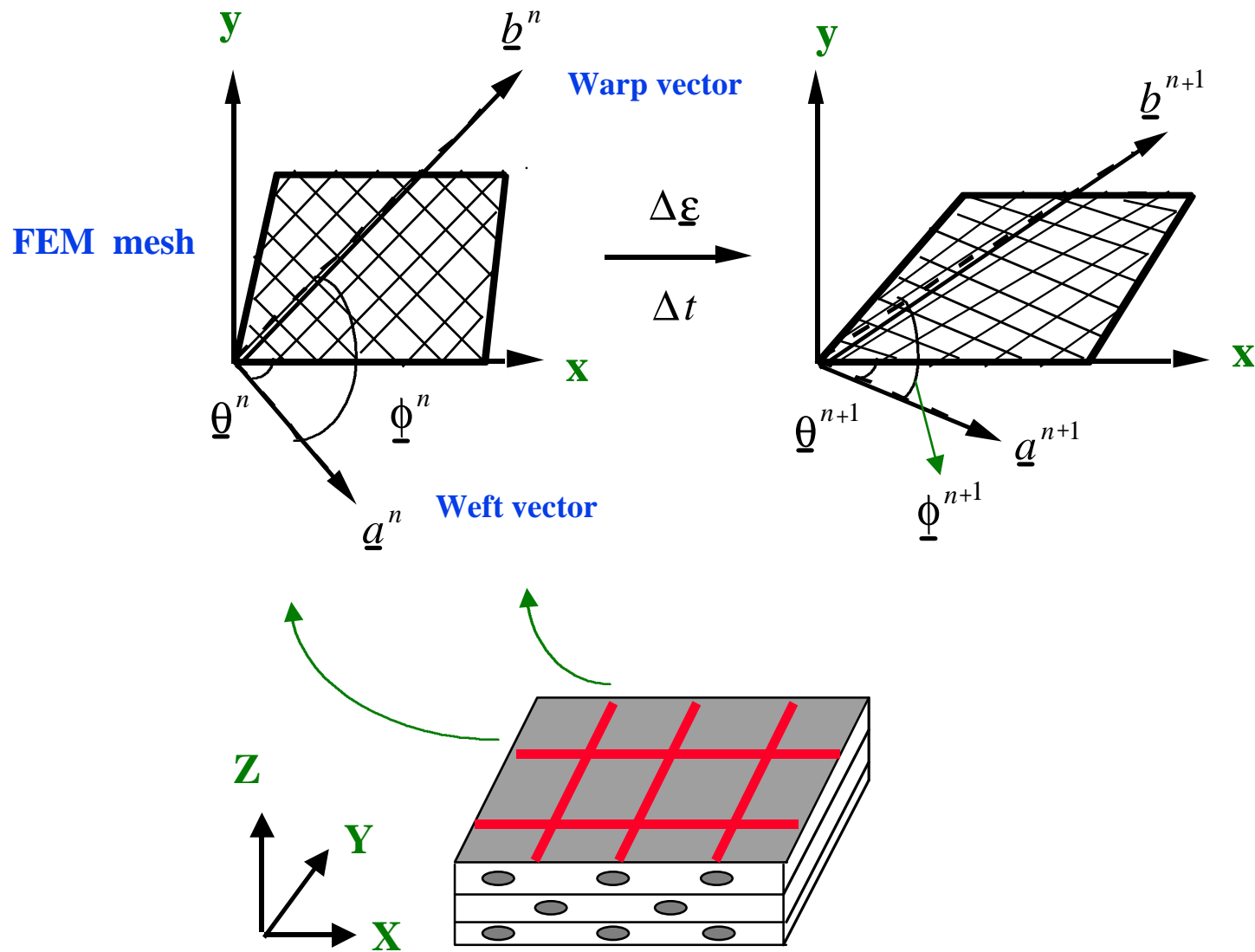



Global-local solution scheme

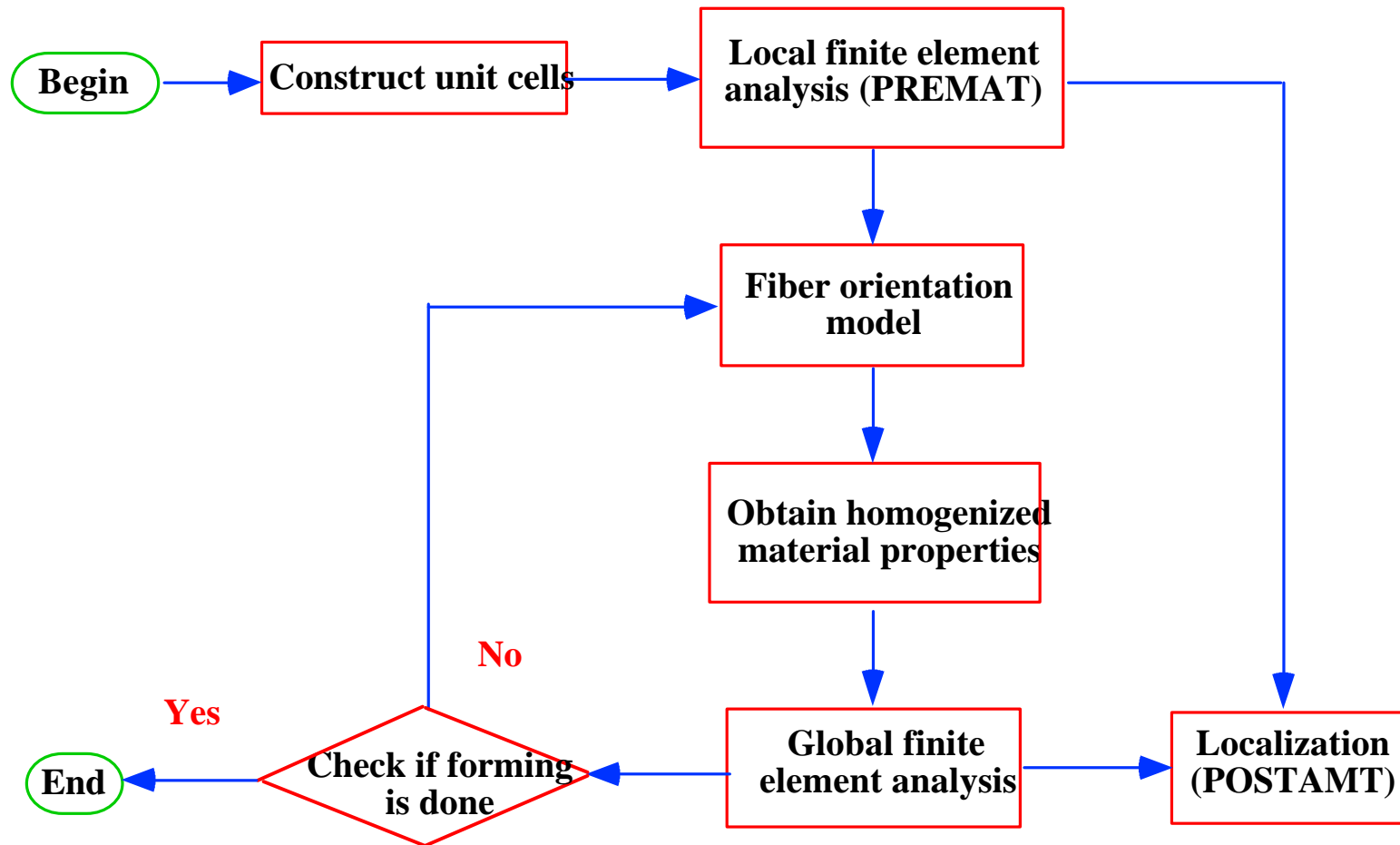



Comparison with experiments (cylindrical cup)

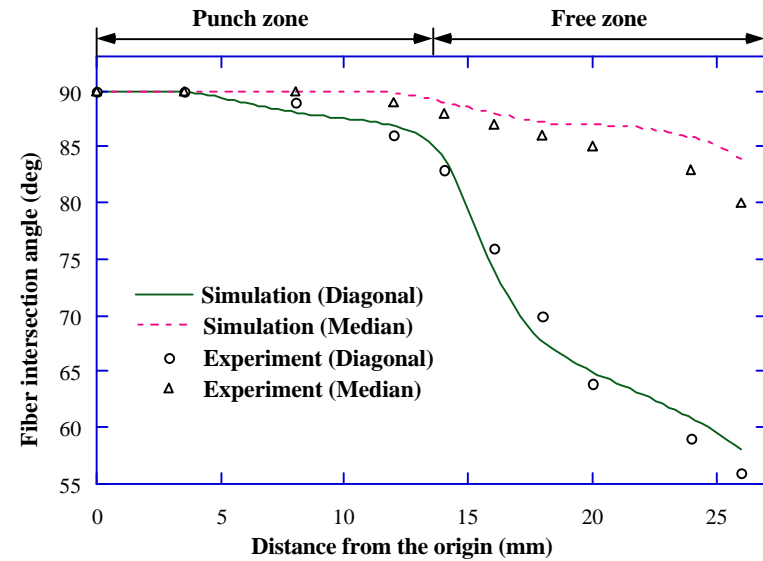
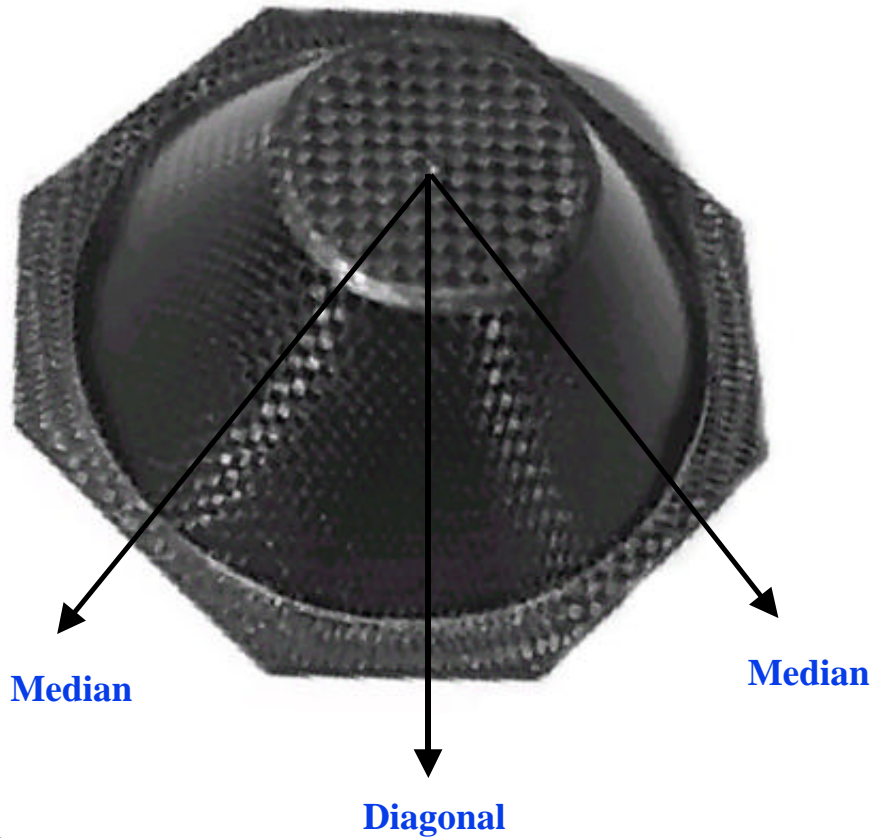



Effective stress prediction (square box)

Laminate

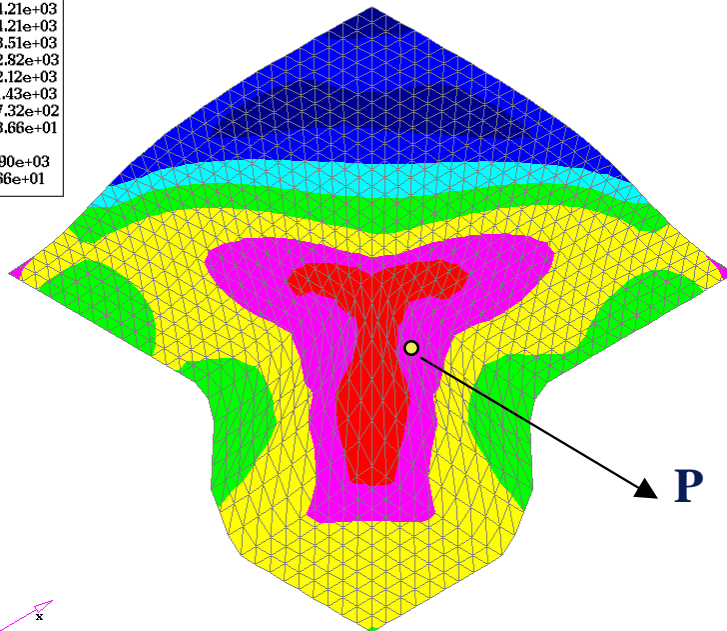
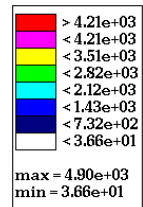

Unit Cell

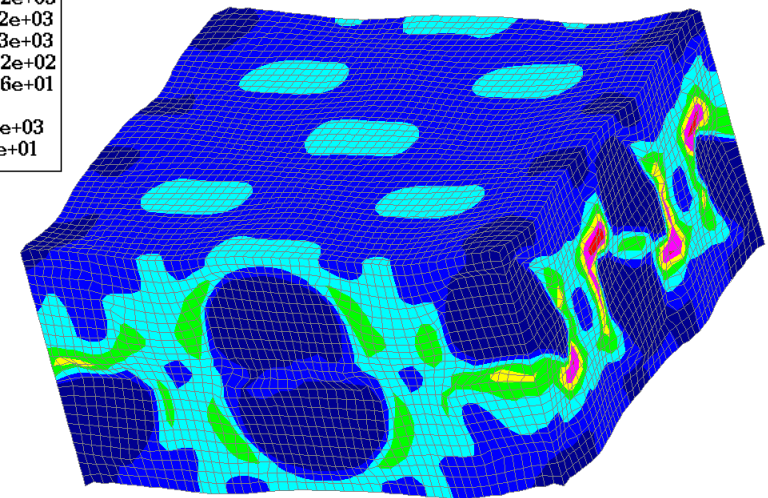
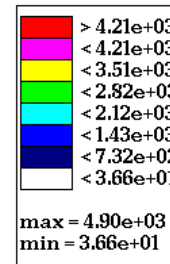

Effective stress of laminate and unit cell at P.



Temperature distribution

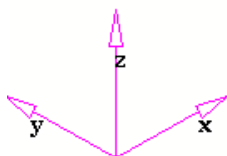
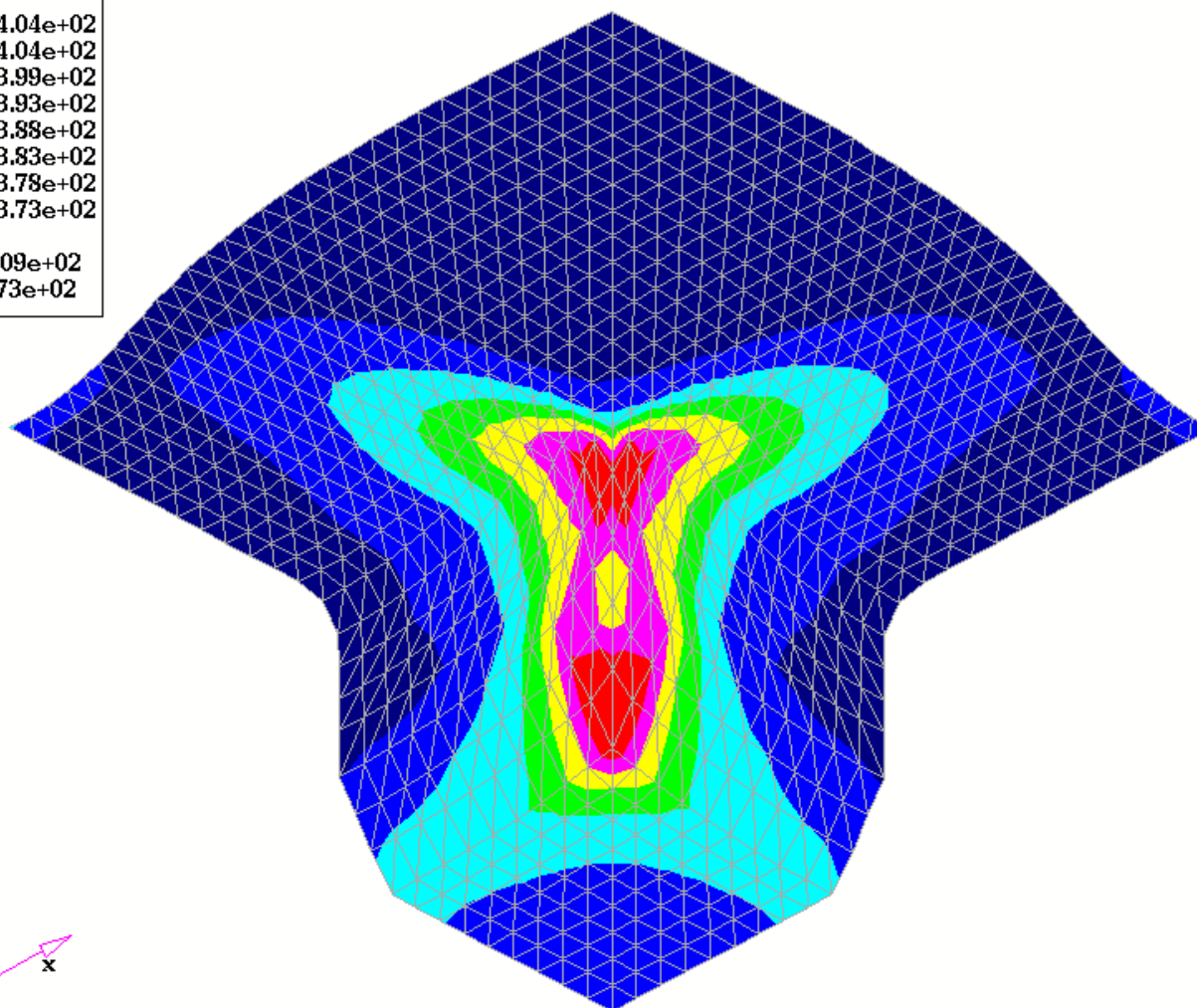
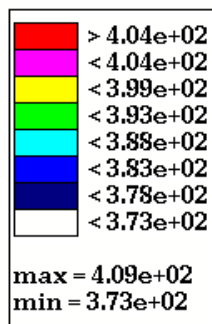



Stamped body panel

Subcase 1
Thickness

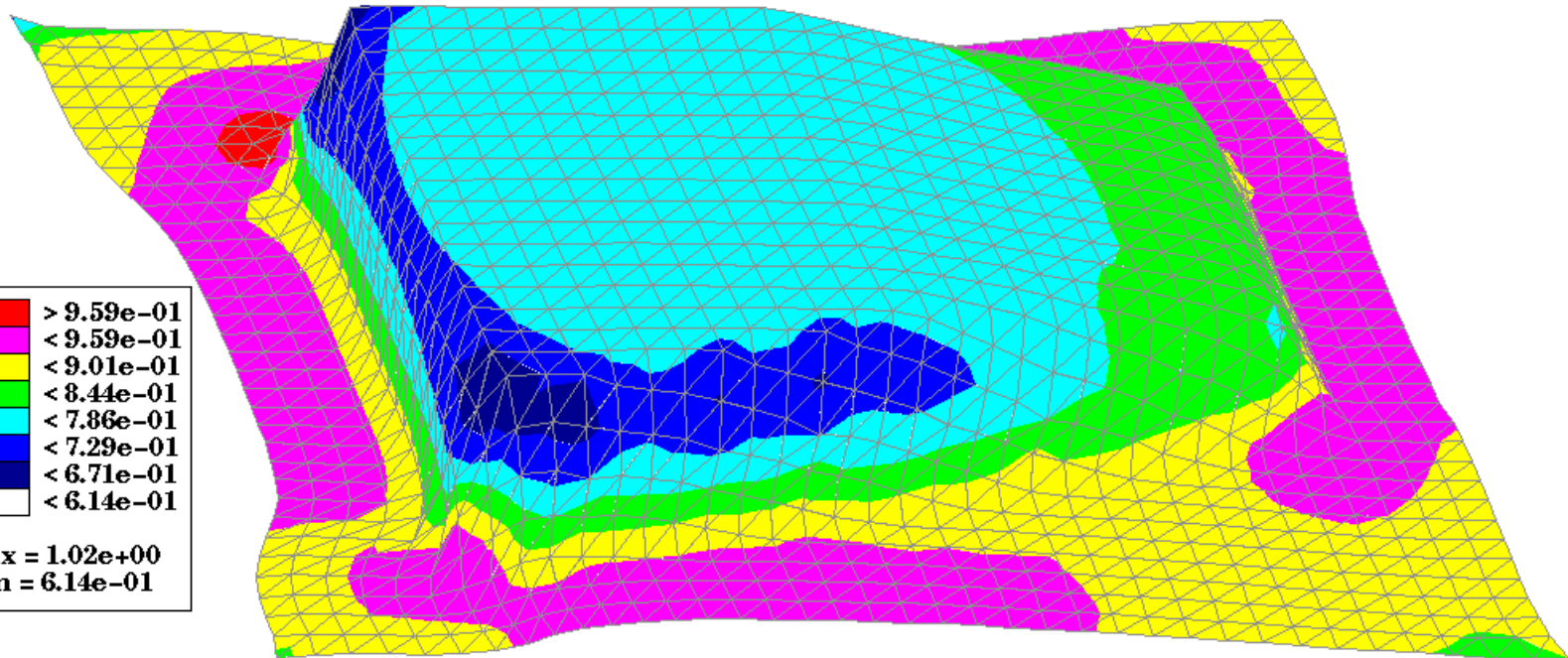
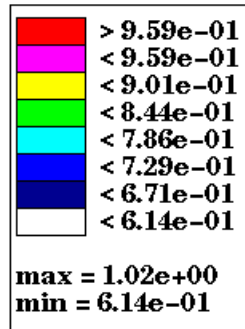



Residual Stress Analysis

- **Three levels of residual stresses are generated during cooling**
 - **Microscopic stress: Due to CTE mismatch between matrix and fiber**
 - **Macroscopic stress: Due to stacking sequence of laminates**
 - **Global stress: Due to thermal history along laminate thickness**
- **Warping due to the release of residual stresses after demoulding.**
- **In this study, homogenization method based on incremental elastic analysis with thermal history is adopted.**
- **Thermoelastic properties are dependent on temperature and crystallinity from the thermal history.**



Thermal history along thickness

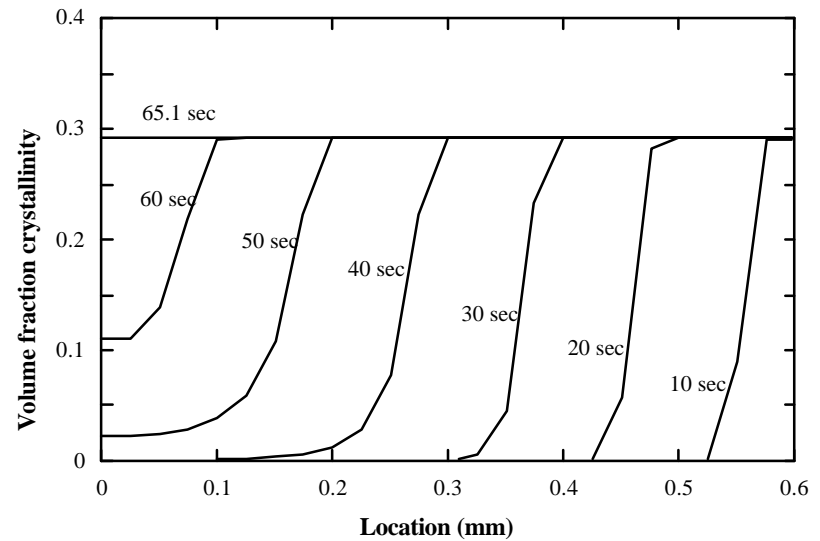
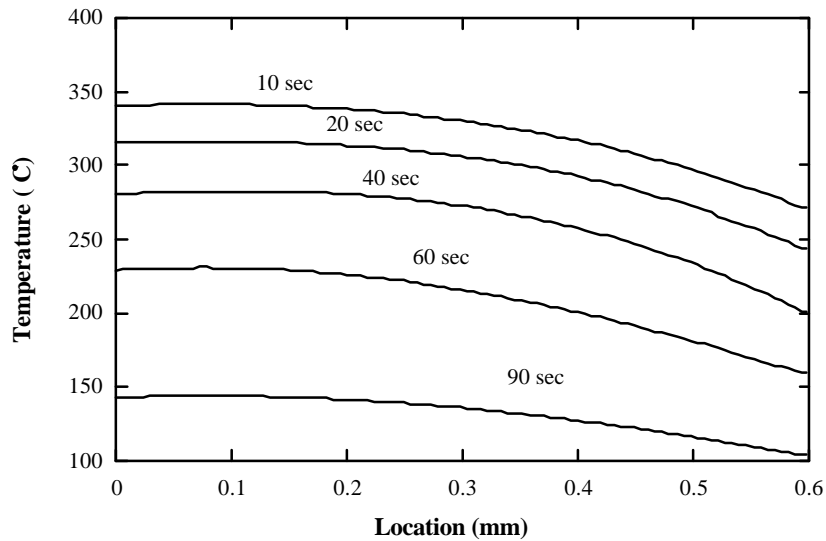
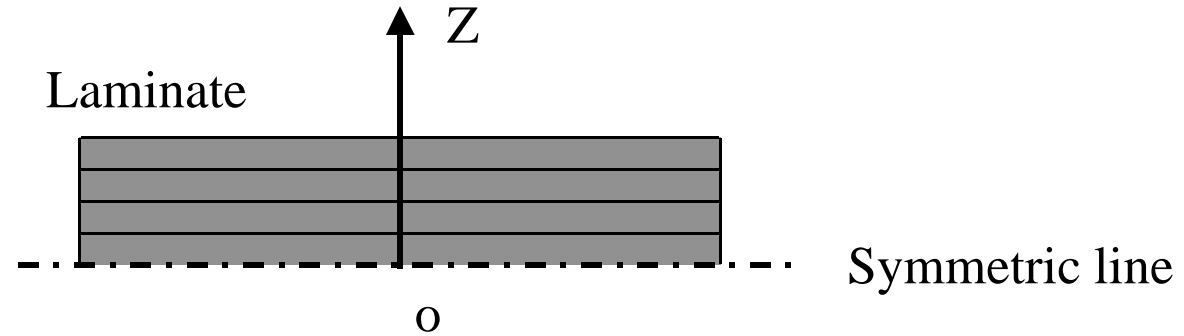



Curvature prediction compared with experimental data

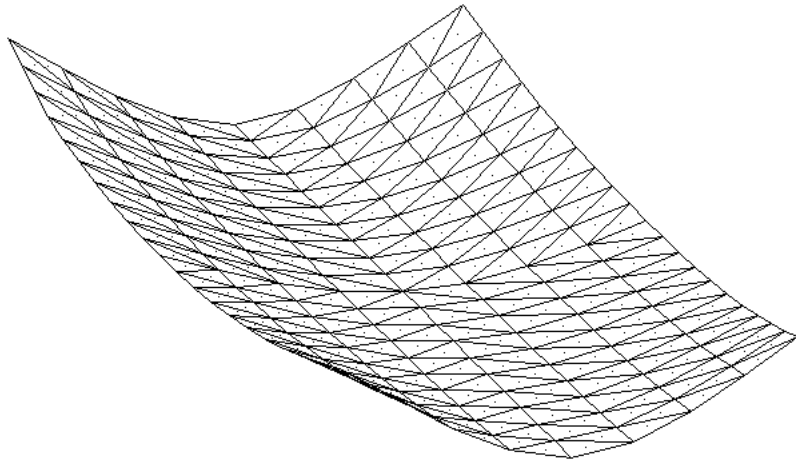

[0/90] asymmetric laminate

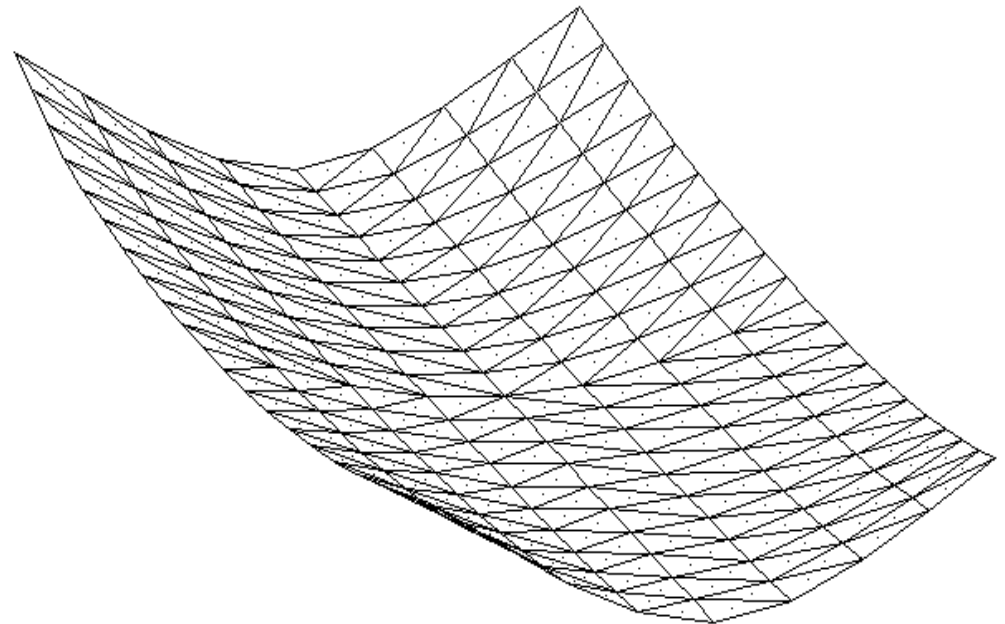

Compared with experimental data



Stress prediction compared with experimental data

Macroscopic stress

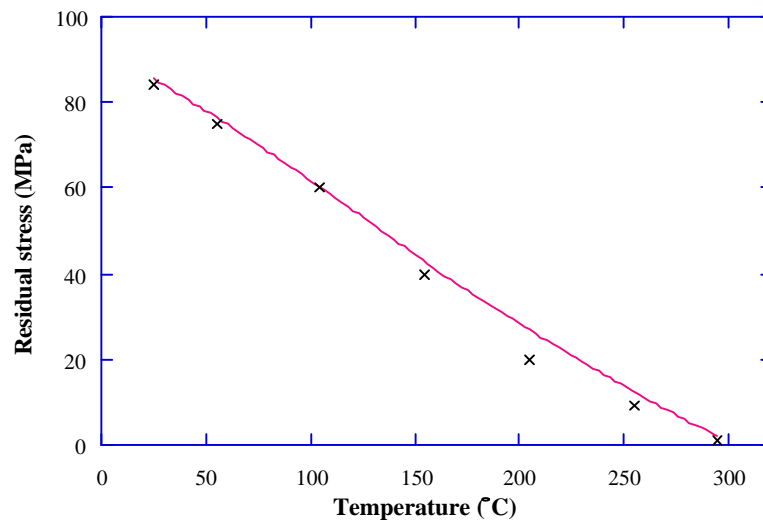

Macroscopic stress prediction for cross-ply laminate compared with experimental data.

Global stress

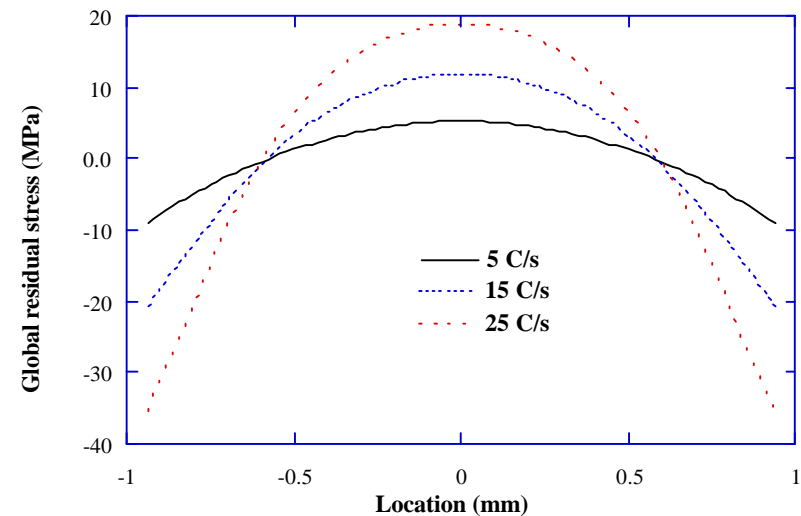

Global stress prediction for unidirectional laminates with various cooling rates.



Warped shapes of square box and cylindrical cup

 Deformed
 Undeformed

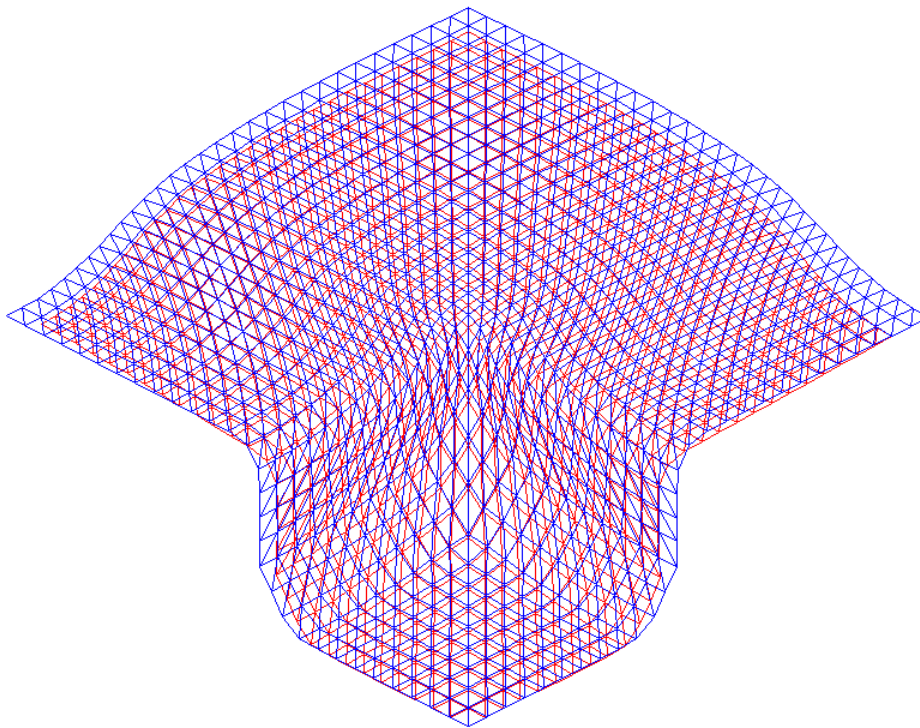

Square box

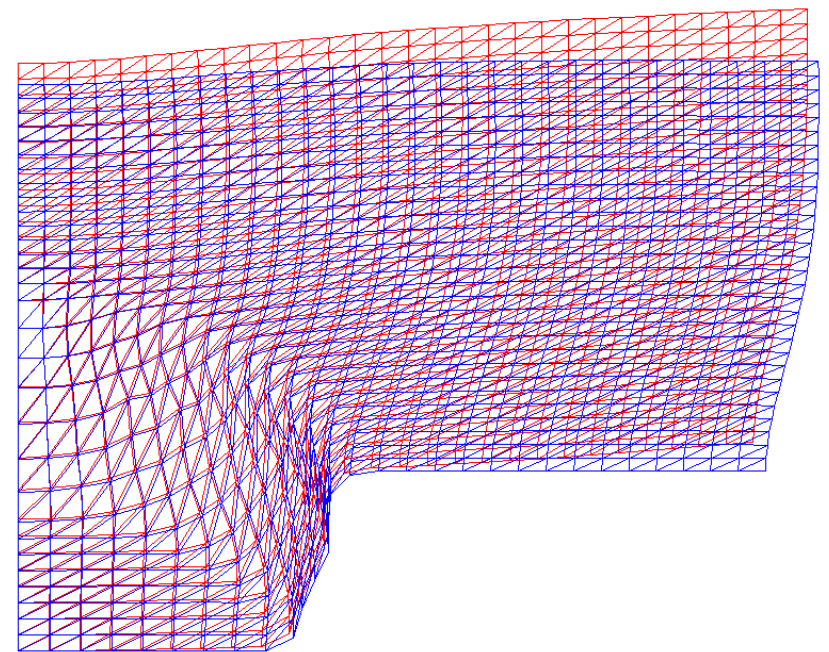

Cylindrical cup



Warped body panel with its microscopic residual stress

 Deformed
 Undeformed

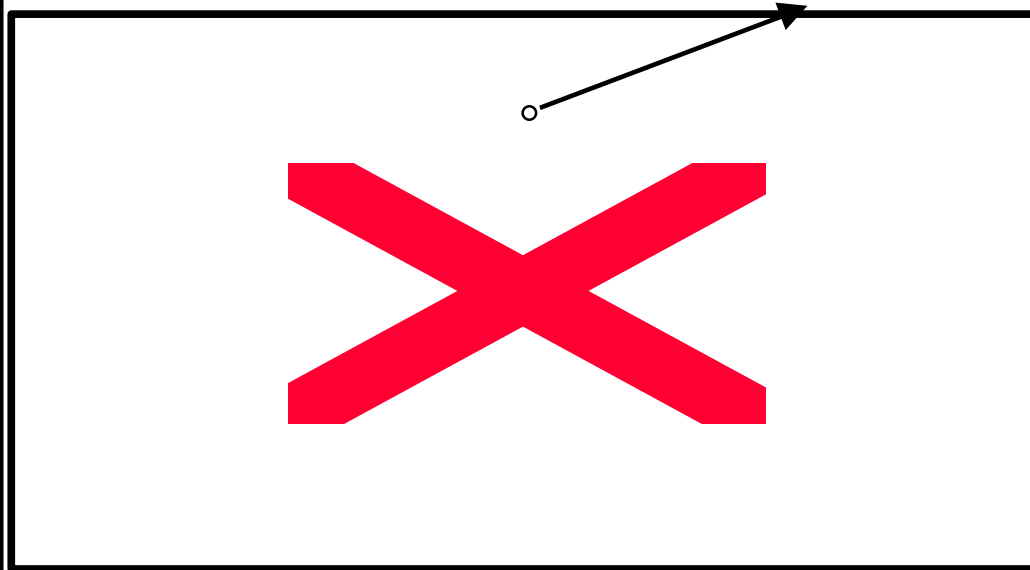
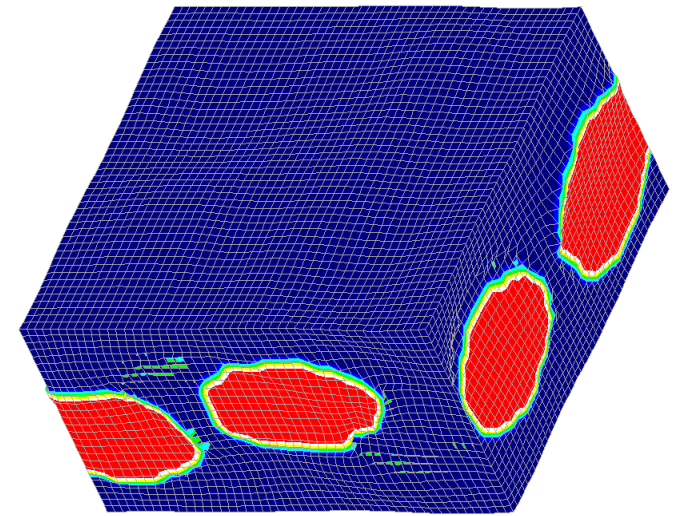
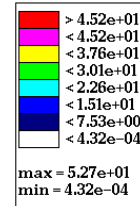

Laminate

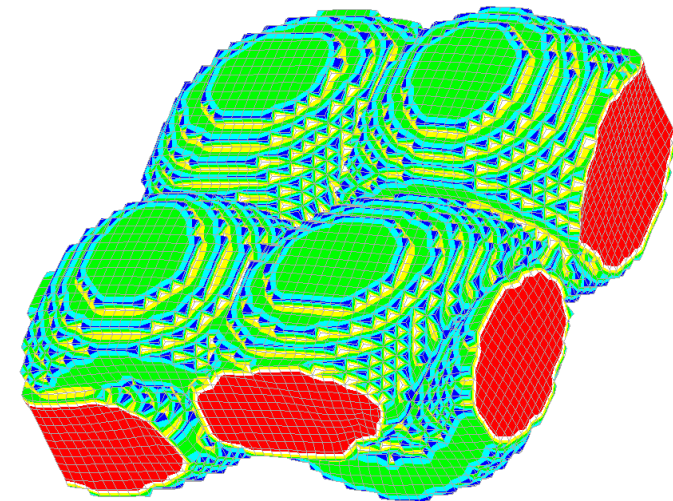

Fiber part

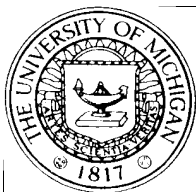

Thickness distribution of original and optimal designs (square box)

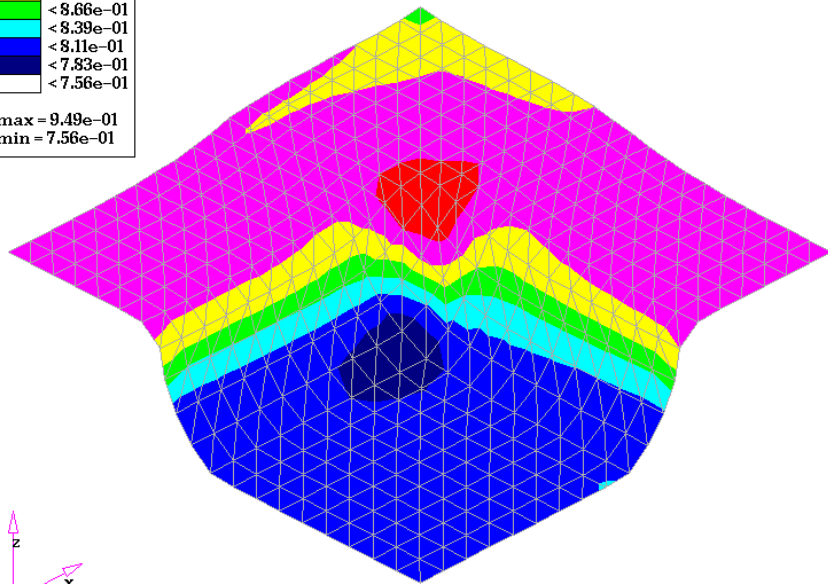
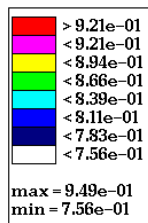

Original design

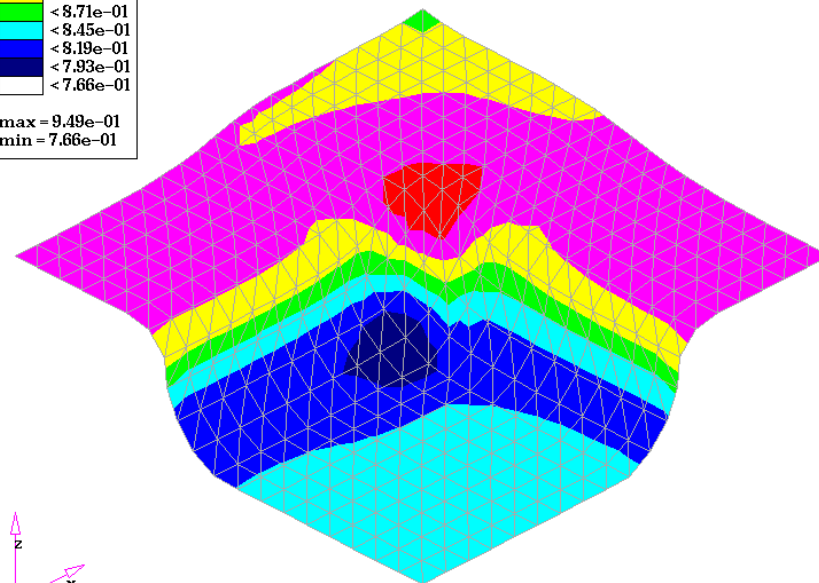
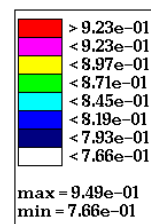

Optimal design



Summary

- **The global-local FEM analysis of thermoplastic laminate stamping process is developed to predict macroscopic and microscopic deformation mechanism by using the homogenization method.**
- **The non-Newtonian composite viscosity with strain-rate and temperature dependency can capture a realistic flow rheology of the carbon fiber/thermoplastic composites at the forming temperature.**



Possible Future work

- **Simultaneous global-local FEM computation is necessary for large deformation if computer capability is allowed : Application of Parallel Algorithms for Speed of Computation.**
- **Inter-ply slip modeling should be included during forming.**
- **Viscoelastic effect is considered in residual stress analysis.**
- **Analytical or semi-analytical differentiation for design sensitivities is essential.**